

# NU-WAY



# Technical data

## automatic oil burners

MODEL  
**C4**  
**C4**<sub>H/L</sub>

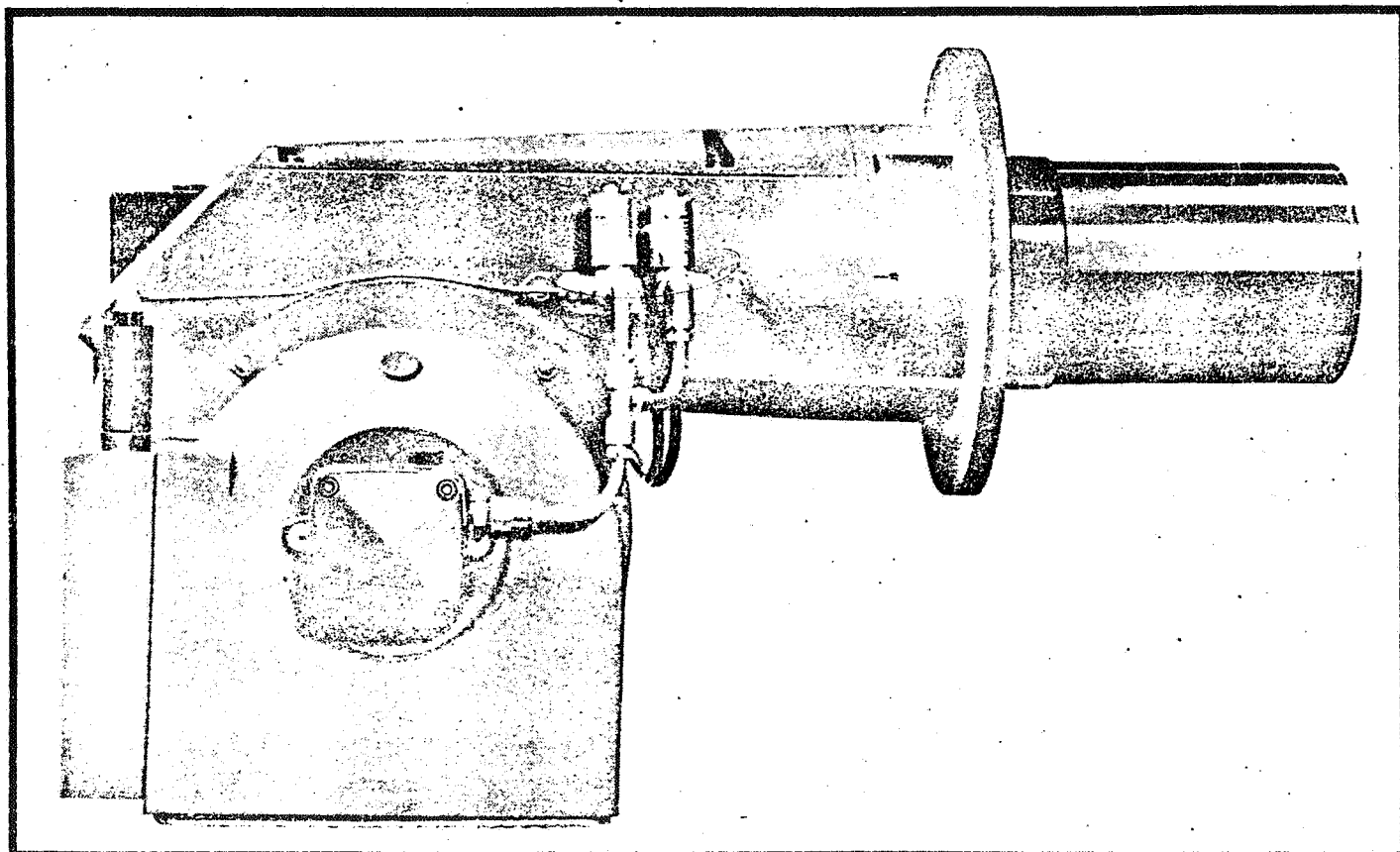
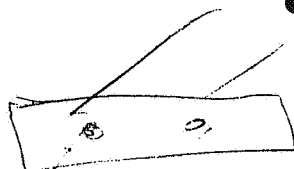

The Nu-way C4 pressure jet burner is designed to meet the requirements of all international markets. It is available in three configurations, namely; C422 on/off—maximum output 540 kW (466,000 kcal/h: 1,850,000 Btu/h); C422 high/low—maximum output 732 kW (630,000 kcal/h: 2,500,000 Btu/h); and C424 high/low—maximum output 469 kW (403,000 kcal/h: 1,600,000 Btu/h). The burner will fire pressurised systems having resistances as listed under burner selection. It will also operate on systems having a maximum draught in the combustion chamber of 10 Pa (1 mm wg: 0.04 in wg).

### FUEL

Light distillate oil (28–40 sec Redwood No 1 at 38°C=1.4–5.7 cSt at 38°C).

### FUEL SYSTEM

Suitable for single pipe gravity or two pipe suction lift systems. Single nozzle operation on/off burners, twin nozzle for high/low burners with 2:1 turn-down. Fuel filter and flexible oil pipe; fuel connection  $\frac{1}{4}$ " BSP female thread.

### CONSTRUCTION

Monobloc metric design using fasteners to ISO standards. Designed for flange mounting. Fan and inner assembly accessible by removal of top cover plate.

### AIR CONTROL

Fixed damper control for on/off operation; hydraulically operated damper for high/low operation.

### CONTROLS

Flame supervision by photo-electric cell with sequence controller to comply with relevant standards. The C4 burner may be controlled by suitable thermostats, time switches, frost thermostats, etc.

### APPROX. WEIGHT

38 kg.

### ELECTRICAL DATA

|                            | 1 phase         | 3 phase      |
|----------------------------|-----------------|--------------|
| Main supply (V) $\pm 10\%$ | 230             | 415          |
| Frequency (Hz)             | 50              | 50           |
| Motor (W)                  | 560             | 560          |
| (hp)                       | 0.75            | 0.75         |
|                            | 2700 rev/min    | 2700 rev/min |
|                            | capacitor start |              |
| Burner start current (A)   | 30              | 9            |
| Burner run current (A)     | 5.0             | 1.5          |

Ignition by direct spark from 10 kV, 35 mA transformer, centre tap earthed.



## BURNER SELECTION

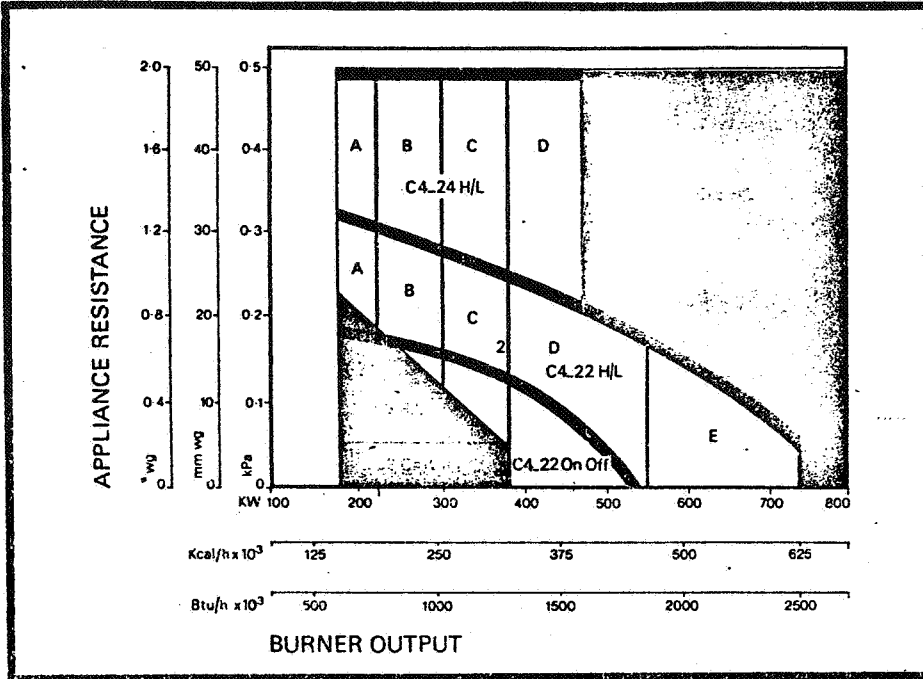

## ORDERING INFORMATION

When ordering a Nu-way model C4 burner please specify the following information in order to expedite your order.

Type of appliance with which the burner is to be used.

Appliance rating and resistance.

Specification of electricity supply locally available, i.e. voltage, frequency, and whether single or three phase.

Type of oil fuel.

Burner selection graph is for C4 burners only. For details of other burners see relevant data.

## DIMENSIONS

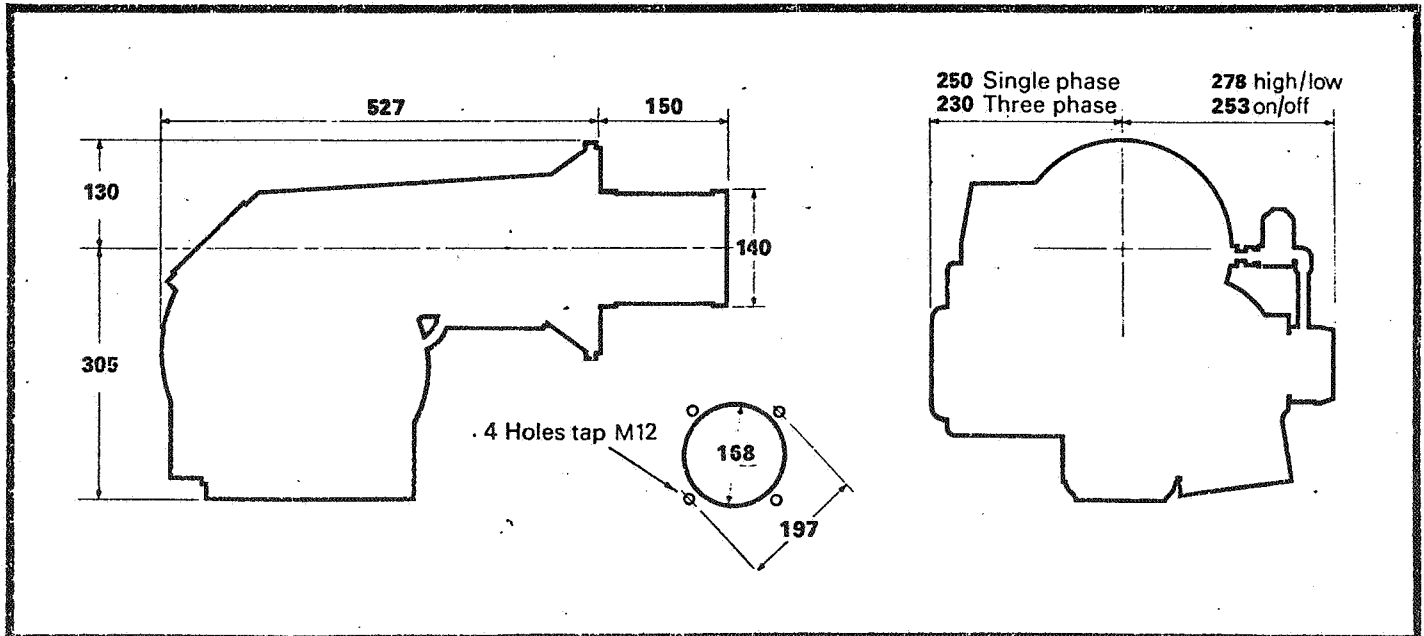

**Nu-way Heating Plants Limited**  
Droitwich, WR9 8NA, England

Telephone: Droitwich (09057) 2331 & 2527  
Telex: 338551. Cables: JASNU DROITWICH

*Nu-way policy is one of continuous improvement. The right to change prices and specifications without notice is reserved.*



INSTALLATION

Installation should be carried out in accordance with British Standard Code of Practice CP 3002 Part 1.

Where the unit is being applied to an existing heating system, arrange for the flue passages and heat transfer surfaces to be cleaned and for the chimney to be thoroughly swept.

Check boiler doors for fit, and seal any cracks and other unwanted openings in the boiler, flue system and chimney brickwork.

The top of the chimney should be above all roofs within a radius of 10m (30ft).

If a cowl is fitted to the chimney it should be removed.

See that the flue pipe from the boiler or heater finishes flush with the inside well of the chimney and does not protrude beyond this point.

No solid fuel fired boiler or heater must be allowed to discharge into the same flue as the oil-fired unit.

Oil supply system and storage tank

Use a single - pipe gravity feed oil supply system whenever possible.

Use a single - pipe system on all installations where the bottom of the storage tank is more than 150mm (6in) above the oil inlet on the burner fuel pump. When using gravity feed the internal bypass within the pump must be open (see instructions packed with the burner pump).

When the pump inlet is higher than the bottom of the oil storage tank a two - pipe, suction lift oil supply system must be used (see instructions packed with the burner pump).

Keep oil pipes out of the way but run them by the most direct path.

Copper tube is easier to work than steel pipe. Iron fittings and steel pipe should be hammered before installation to remove loose scale.

Galvanised pipe and fittings must NEVER be used.

Do not join copper tubes with soldered joints or capillary fittings.

For screwed pipe connections use a mastic type of jointing compound or plastic tape, NOT a hard setting paste.

When oil is fed to the burner by gravity use 9,5mm ( $\frac{3}{8}$ in) outside diameter pipe or larger.

On suction lift systems the pipe size should be chosen in accordance with the pump maker's recommendations (see pump makers instructions at back of this handbook).

Incline all pipe runs slightly to avoid air traps. Fit a tee - piece and plug at any point where air is likely to be trapped, ie at the highest point in any run.

The oil storage tank should be located outdoors. If the tank must be installed indoors check the local fire regulations. Place indoor tank in a separate fire-resisting chamber: if this is not possible the tank must be mounted within a catch-pit having a capacity at least 10% greater than that of the tank.

Do not mount the tank on a roof except as a very last resort.

Mount tank with 20 - 40mm per metre fall ( $\frac{1}{4}$  -  $\frac{1}{2}$ in per foot) away from oil outlet towards the sludge cock.

Fill and vent lines should be of the same size in accordance with the oil supplier's recommendations.

Fit a fusible link actuated fire valve as near as possible to the storage tank outlet. Fit extra fusible links near the tank if it is installed indoors and in any enclosed passages through which the oil pipes run.

#### Electrical wiring.

Wiring information is to be found on the diagram supplied with the boiler or air heater unit or enclosed with this handbook. Wiring diagrams showing electrical connections for all Nu-way burner/control combinations are available on request, from the Electrical Department, Nu-way Heating Plants Limited, Droitwich.

PVC cable may be used for all wiring runs except those near hot surfaces. Runs in these areas should be executed in asbestos insulated cable. Use flexible conduit when wiring the final connections to the burner and the thermostats.

Ensure good earth bonding of all burner component units by running a separate earth wire or strip along each flexible conduit to the fitting at each end.

#### Appliance front plate drilling

The frontplate of the appliance unit must be drilled in accordance with the accompanying drawing in order that the burner may be mounted on the appliance in a satisfactory manner.

#### Damper

On single boiler installations lock the flue damper in the fully open position.

If occasional closing of the damper is necessary, as on multi-boiler or heater installations, arrangements must be made to make closing of the damper impossible without removal of a locking device, eg padlock. If the draught over the fire exceeds 0.2 mbar (0.08in wg) a draught stabiliser should be fitted in a position recommended by the makers. When the burner is running the draught over the fire should be between 0.05 and 0.125 mbar (0.02 - 0.05in wg).

#### Quiet operation

To ensure quiet burner operation several precautions should be taken.

The final connection between the oil supply pipe and the burner should be made using a flexible pipe.

Pipes should be insulated from one another, from the joists of the building, and from the walls, by means of suitable clips.

Neither the burner flange nor the draught tube should touch the boiler frontplate. A gasket is supplied with each burner to ensure that the former condition is met. If the appliance frontplate is drilled in accordance with the drawing shown on the data sheet the latter condition will be satisfied also.

#### Testing the installation

Bleed the oil supply line free of air up to the burner.

Bleed the burner pump free of air by slackening off the plug in the pressure gauge port and running the burner motor BRIEFLY (see pump maker's instructions at end of this handbook).

Remove burner inner assembly and check that electrodes are set in accordance with the drawing. Replace the inner assembly.

Close main electrical switch. The burner should start. Leave it running for about 30 minutes in order that the fire box may dry out.

Check all pipework and connections for oil leaks.

Check that thermostats switch burner off by adjusting each thermostat, in turn, to a temperature below that actually existing in the boiler or air heater.

Check operation of the control box by removing the photo-electric (pe) cell while the burner is running. Cover the pe cell to exclude all light.

Burner should stop and go to 'lock-out'.

Fit pressure gauge (having full scale deflection of, say 0 - 40 atm: 0 - 600 lbf/in<sup>2</sup>) to gauge port of pump (see maker's data sheet at back of this book).

Restart burner, by pressing reset button, and check that the atomising pressure is correct. If adjustments are necessary in order to obtain a satisfactory oil pressure follow the pump maker's instructions.

When the heating plant is warm check combustion efficiency with a CO<sub>2</sub> sampling instrument, if available. Adjust burner air supply to give<sup>2</sup> an acceptable reading: it is suggested that a minimum value of 10% CO<sub>2</sub> should be the aim.

If a CO<sub>2</sub> sampling instrument is not available adjust the air supply so that there is a slight haze at the top of the chimney.

#### Instructing user

Show the completed installation to the user and demonstrate starting and stopping of the burner: instruction should include both stop and emergency stop.

Demonstrate, also, resetting of the air supply adjustment control.

Correct thermostat settings should be indicated.

Demonstrate procedure for desludging oil storage tank before each fuel delivery.

Urge user to conclude service agreement with the installer.

NOTE:- Before attempting to fire burner check that fan or motor shaft on 3 Ph motors rotates in correct direction. If incorrect change over any two of three phases feeding motor and recheck.

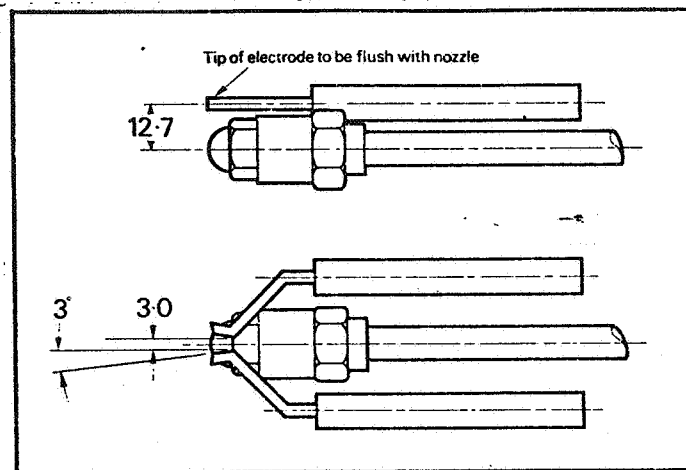

Electrodes should be set to these dimensions to ensure trouble free ignition. Dimensions are in millimetres.

### ELECTRODE SETTING ON/OFF BURNER

OPERATIONFuel

The burner is designed to burner light distillate oil to BS 2869:1970, Class D<sub>2</sub>. (35 seconds Redwood No 1 at 100<sup>o</sup>F; 3.8 cSt at 20<sup>o</sup>C).

Do not attempt to use petrol, crankcase oil or any oil which may contain traces of petrol.

Starting and stopping

Start the burner by setting the thermostat pointer to a figure which is higher than the room or water temperature.

Stop the burner by setting the thermostat to a point below this temperature.

The burner may set itself in the 'safety lockout' position - this will occur if the burner stops for any reason other than the action of the thermostat - and must then be restarted by pressing the reset button on the flameguard/sequence control. Instruct the user in the correct method of resetting. If frequent resetting becomes necessary call the service man.

Do not attempt to start the burner when the fire box may be full of oil vapour. It is desirable to allow the furnace to cool for about 15 minutes before resetting the control to restart the burner from the 'safety lockout' position.

Emergency stop

The burner can be stopped in an emergency by opening the electrical switch provided in the line between the burner and electricity supply. The installer must identify this switch which is frequently mounted on the wall of the boilerhouse adjacent to the appliance itself.

Checking burner operation

Inspect burner flame periodically; if it becomes lop sided or smokey, call the service man.

When cleaning the room housing the heater unit always switch off the burner to reduce the amount of dust and lint drawn through the air inlet.

Summer care, autumn restart

During the summer months, or whenever heat is not required over a considerable period, the main electricity isolating switch, often wall mounted and referred to as a wall switch, may be opened (operated to OFF position). To restart the burner it is only necessary to close this switch (operate to ON position).

At the beginning of the heating season have the furnace cleaned and flues swept. See that the complete burner plant, especially the electric ignition system, nozzle, oil filter etc, is checked over and cleaned by a competent service man.

Preventative maintenance

Consult your heating engineer for advice on regular preventative maintenance intervals. It is not possible to recommend a service interval for universal use since operating conditions vary widely from installation to installation.

Pump Bleeding

If the oil storage tank is allowed to drain completely it will be necessary to bleed the oil pump free of air. This is effected by slackening the plug in the pressure gauge port and (briefly) running the burner motor (see pump maker's instructions).

Oil filtration - sediment removal

There is an oil strainer inside the body of the oil pump and a separate oil filter in the pipe between storage tank and the burner. The oil strainer should be removed and cleaned with paraffin during the pre-season check-up. At the same time the oil filter cartridge should be replaced or cleaned as appropriate for the type fitted. Bleed the oil pump free of air, as already described, to remove any trapped air.

Draw off any accumulation of water or sediment in the oil storage tank by opening the sludge cock in the tank bottom immediately before any new delivery of oil. Do not run the burner while the tank is being refilled and, if possible, do not restart burner for one hour after refilling has been concluded: this allows sediment in the new oil to settle, thus minimising burner troubles which can be attributed to dirty fuel.

Caution

Never burn rubbish or refuse in the fire box.

Never leavewaste paper or rags lying around near the burner or heater.

Electrical Connections

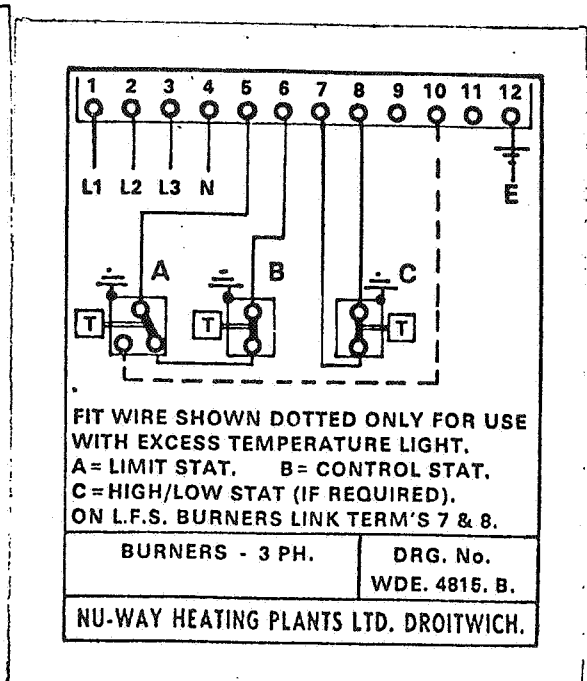
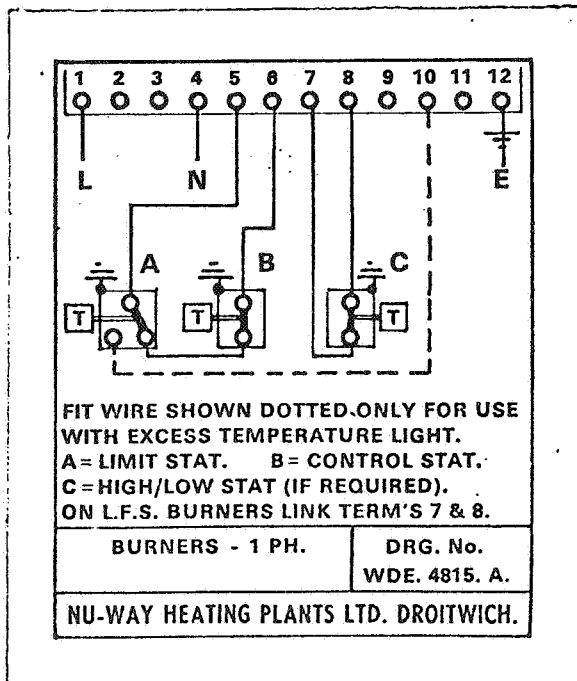



MAINTENANCE - C<sub>4</sub> & C<sub>4</sub> H/L BURNERS

BEFORE CARRYING OUT ANY WORK ON THE BURNER ENSURE THAT THE MAIN ISOLATING SWITCH IS OFF.

FUEL PUMP

For maintenance refer to the maker's information at the back of this handbook.

NOZZLE(S) AND ELECTRODES

Undo the screws retaining the top cover and remove.

Undo the two screws at the side of the fan casing which retain the inner nozzle assembly, taking care to support the latter to prevent the latter falling inside. Gently withdraw the inner assembly, detach the H.T. lead connectors by a straight pull and remove from burner.

The nozzle(s) can be removed using a box spanner and should be cleaned as follows:

Unscrew the inner core and clean the nozzle body, swirler and core, separately. Take care not to scratch the nozzle. Flush oil away with solvent or under a running water tap, or with compressed air line. Scrape only when dirt is visible and then use only cardboard or paper, rather than wood. NEVER, but never, use a metal scraper.

Re-assemble, taking care to ensure all the parts are kept very clean, and replace.

Do not allow dirt to enter the nozzle pipes while the burner is dismantled.

Clean electrodes and insulators, inspect insulators for cracks and replace if necessary.

Reset electrodes to the correct position - see electrode setting drawings.

MOTOR

In general, maintenance is limited to keeping the motor clean and dry. Where applicable lubricate burner motor every six months using SAE 20 oil - a few drops only - do not over lubricate.

OIL FILTER

Renew disposable element type each year. Permanent element type should be washed once per year, unless dirty oil supply is suspected. It may be necessary to bleed the pump after this operation, in order to remove air from supply pipe.

CONTROL

Clean the photo-electric cell head regularly - say once a month. Be sure to replace cell in correct position ie with viewing face looking towards the flame.

FAN

Keep fan blades clean and free from oil or fluff. Use paint brush for this purpose.

COMBUSTION HEAD

Clean air handling parts and draught tube with soft brush as shown taking care not to distort diffuser.

FAULT FINDING.Burner fails to start at all.

One of the instruments in the control circuit may not be closing, ie the affected instrument is not 'calling for heat'. Check the control or limit thermostat, pressure switch, time switch or room thermostats.

The photo electric flame-viewing cell may be incorrectly energised by daylight.

Red warning light illuminated on controller.

Burner starts but fails to light, then locks out

There may be no spark at the electrode points. Check that the HT leads are securely connected to both transformer terminals and ignition electrodes. The spark may not ignite the oil. Check the positional settings of the electrodes and ensure that the spark gap is correct. A partly blocked or damaged nozzle can cause an uneven spray pattern. Low oil pressure will cause a narrow spray.

No oil in storage tank or the oil level is below that of the outlet pipe leading to the burner.

The oil supply line may be restricted. Check the foot valve (if fitted), stop valves, anti-syphon valve (if fitted), fire valve and filters. Check also for a blocked nozzle.

The motor-to-pump coupling may be failed through overload or the driving dog may be loose.

The oil pump may be faulty.

Air may be leaking into the oil supply pipes, particularly on suction lift systems. This fault is often indicated by a noisy pump. Check all joints at filters, valve and pump glands, pump cover and pipe joints. On single-pipe oil systems there may be insufficient gravity head: on two pipe systems the suction lift may be too great or the internal bypass plug may not be fitted in the pump. Note that it is essential to install a return oil line back to the storage tank when an internal by-pass plug is fitted to the pump.

Burner starts and lights then locks out

The photo-electric cell may be dirty or faulty and remaining on its 'dark' contact. This may be due to the cell itself or amplifier or wiring being faulty.

Small sparky flame

This condition may be caused by a partly blocked nozzle which will produce an uneven flame.

Too much air will produce the same symptoms.

Smoky flame

Oil pressure may be too high.

The swirler in the nozzle may be loose or the whole nozzle may be loose in its adaptor; both can produce a large flame.

The nozzle may be worn thus causing a very large flame.

The air supply may be insufficient.

The draught may be inadequate. Check the boiler flues and the chimney; look for leaks everywhere. If a chimney pot is fitted, remove it. Establish whether the chimney is subject to downdraughts.

Blow-back on lightingFumes in boilerhouse.Oil and soot on combustion head and in draught tube.

These conditions may be caused by delayed ignition. Check electrodes etc. There may be a restriction in the flue and/or the chimney.

Low oil pressure

The pressure regulating valve may be sticking or require adjustment. Free the valve and set to the correct operating pressure.

High oil pressure

The pressure regulating valve may be sticking or require adjustment. Free the valve and set to the correct operating pressure.

On two-pipe systems there may be a restriction in the oil return line to the oil storage tank.

Extremely high oil pressure may be caused if an internal by-pass plug is fitted in the pump but no oil return line to the storage tank. Restriction in, or lack of, an oil return line can cause serious damage to the pump, motor or flexible coupling.

Noisy burner

A restriction in the oil supply line or air leaks into the supply line can cause pump noise. Too great a suction lift has the same effect.

If fan runner is loose on its shaft burner will be noisy.

Worn or dry motor bearings generate noise.

## INITIAL FIRING AND FAULT FINDING INSTRUCTIONS FOR MODELS WITH HIGH/LOW/OFF CONTROL

### INTRODUCTION

High/Low models differ from the simpler on/off models in the following respects:

There are two atomizing nozzles arranged vertically above each other, each controlled by a magnetic valve. The top nozzle only sprays on low flame whilst both nozzles spray on high flame. The air inlet damper is adjusted to suit the rate of firing by a hydraulic ram operated by oil pressure from the high flame magnetic valve against a return spring within the ram itself. The high flame magnetic valve is energised by the H/L appliance controlling instrument during normal running, but is always de-energised for 15 to 30 seconds (dependent on the control box fitted), at each burner start, thus giving a low flame light up. The low flame magnetic valve and the burner motor operate together and are controlled by the on/off appliance controlling instrument. A limit instrument is normally fitted to the appliance also.

While the burner is both at rest and on low flame, the ram is fully retracted by its internal spring, and the low flame air adjustment is made at the point where the flap lever contacts the adjustable stop screw.

When the burner is on high flame the ram is extended, and the flap lever contacts the high flame stop located immediately above the low flame stop screws. This is used to adjust the high flame air. (See illustration).

### INITIAL FIRING

FOLLOW THE INSTALLATION INSTRUCTIONS FOR ON-OFF BURNERS. Up to but not including "Testing the Installation".

### TESTING THE INSTALLATION

Bleed the oil line to the burner. Bleed the pump free of air by slackening off the plug in the pressure gauge port and briefly running the burner motor (see pump maker's instructions). Remove the burner inner assembly (see page 3) and check that the electrodes are set in the correct position (see diagram).

Set the appliance H/L controlling instrument to the required operating temperature (or pressure). Initially set the on/off control instrument to a temperature some 10° F above this. Set the limit instrument 10° F above the H/L setting.

Remove the cover from the damper mechanism at rear of air inlet. Initially, set the air damper one third open by means of the low flame stop. Manually extend the ram and set the high flame stop so that the damper can open almost fully. Turn on the burner and allow it to start. It will light on low flame and, in 15 to 30 seconds (dependent upon the model of control box fitted) change to high flame. Adjust the high flame stop to give a clean flame without unnecessary excess air and then run the installation for fifteen minutes approximately (until it is at normal running temperature).

Whilst still on high flame, again re-adjust the high flame stop to give a CO<sub>2</sub> reading of 10% to 12% (or as specified by the appliance manufacturer) - (See notes). Reduce the setting of the H/L control instrument until the burner changes to low flame. Adjust the damper linkage until a CO<sub>2</sub> reading 8% to 10% (or as specified by the appliance manufacturer) is achieved. See notes.

Reset the H/L control instrument, replace mechanism cover.

#### NOTES:

The higher the CO<sub>2</sub> reading, the higher the appliance efficiency. This always assumes that the flame is clean. A dirty flame will soot up heating surfaces, lead to low appliance efficiencies and frequent cleaning. The maximum CO<sub>2</sub> setting with clean combustion will depend upon the rate of firing, the type of appliance and the effectiveness of its sealing. If only a very low CO<sub>2</sub> reading is obtainable with a clean flame reduce the appliance draught (eg. adjust draught stabilizer) and recheck. If much higher CO<sub>2</sub> readings are obtainable search for appliance air leaks and seal these. The smoke number should not exceed number 2 and should normally be 0 to 1, (Bacharach scale).

Run the burner under normal load and check that the appliance control and limit instrument settings are satisfactory for the plant.

The oil pressure used on high/low burners is (unless otherwise specified) 140 p.s.i.

#### FAULT FINDING

The fault finding section for on-off burners apply generally to the H/L models. However, additional notes on fault finding for H/L burners are as shown.

## FAULT FINDING HIGH/LOW MODELS

## BURNER WILL NOT CHANGE TO HIGH FLAME

Check the settings and operation of the H/L thermostat (or pressure switch) - H/L magnetic valve failing to open. (Faulty valve or no high flame signal from control box).

## FLAME FAILURE ON CHANGING TO HIGH FLAME (or small sparky high flame).

High flame nozzle blocked.

## MOMENTARY FLAME FAILURE ON CHANGING TO HIGH FLAME

Restricted or insufficient oil supply to burner. (This causes a fall in oil pressure when increased flow is needed to supply ram and high flame nozzle).

## LARGE SMOKEY FLAME ON CHANGING TO HIGH FLAME

Air shutter sticking in the low flame position. Oil line to ram blocked (this specially applies if a restrictor is fitted in this line).

## BURNER WILL NOT CHANGE TO LOW FLAME (except on initial start)

Check setting and operation of H/L control instrument.

## BURNER STARTS ON HIGH FLAME

Faulty control or separate timer incorrectly set or faulty.

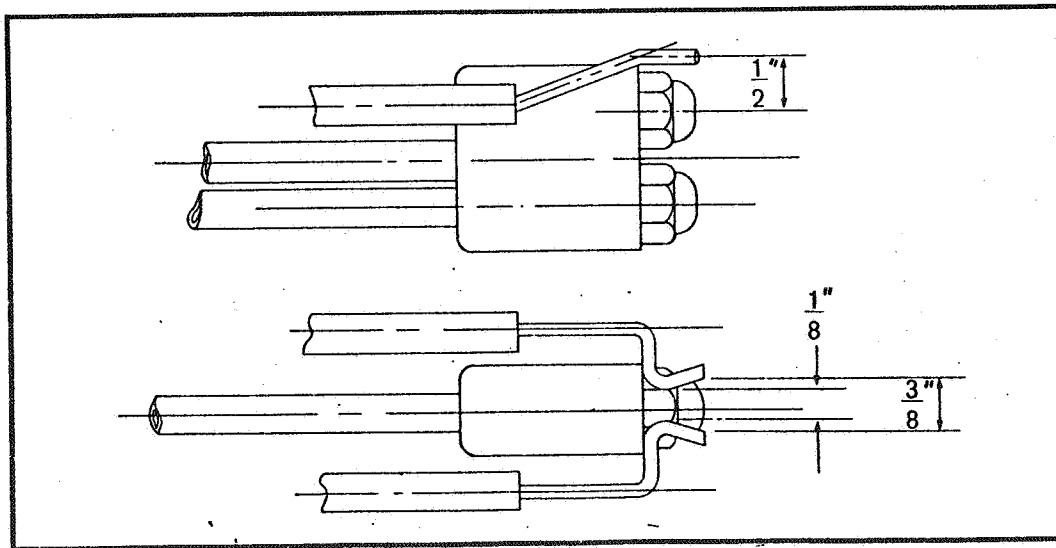

ELECTRODE SETTING C4 H/L

# E INSTRUCTIONS

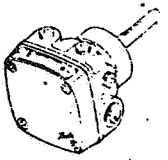

## Compact Oil Pump Type RS

**1** Check direction of rotation which is shown by the arrow on the data plate. ("Right-hand pumps" rotate clockwise and "Left-hand pumps" rotate anti-clockwise. Look towards shaft end.)

**2** Mount the pump. It can be mounted as shown below, but it is advisable to use position a; if this is not possible, then position b and so on.

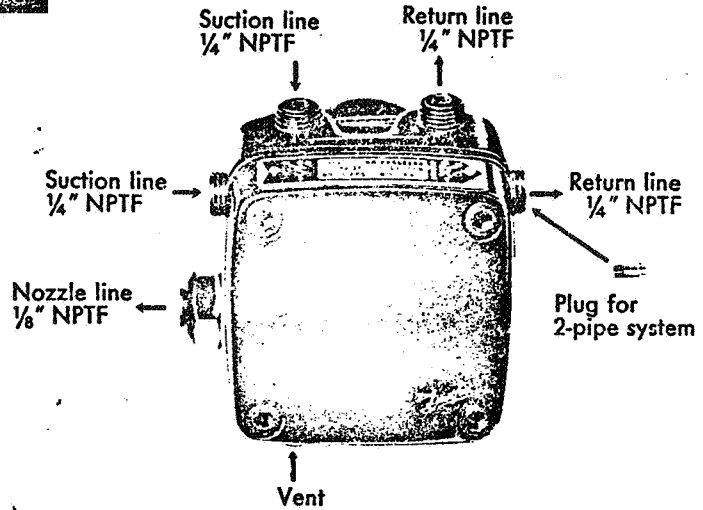

Different ways of mounting

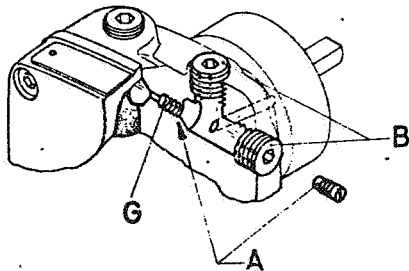
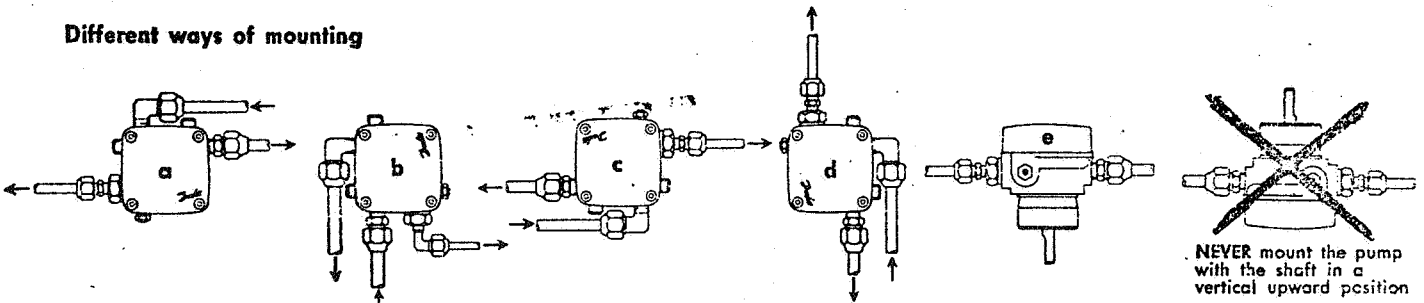

**3** Arrangement for 1-pipe or 2-pipe system  
**CHECK!** When supplied, RS is always arranged for 1-pipe system.  
 If the pump is to be used for a 2-pipe system the plug "A" must be fitted, and the return line be connected to one of the connections "B".

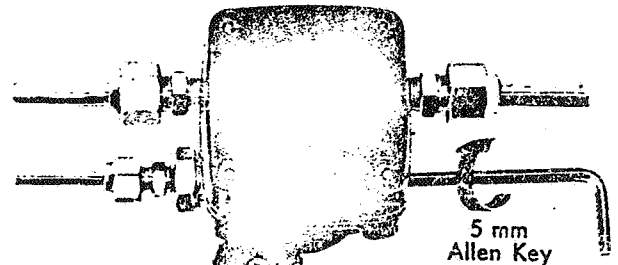
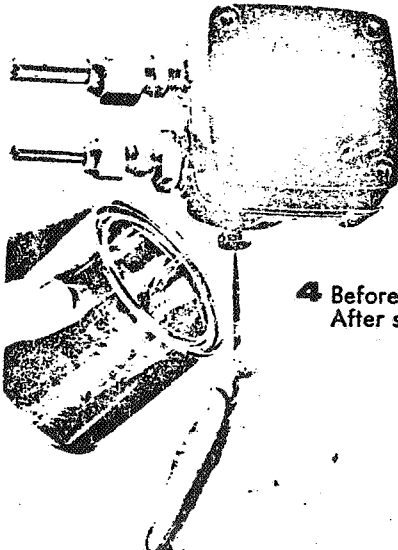

**4** Before start-up: Check direction of rotation of motor.  
 After start-up: Vent the pump, nozzle tube and nozzle.

Change of oil pressure  
 Max. 200 psi (14 kg/cm<sup>2</sup>)  
 Min. 80 psi (5.5 kg/cm<sup>2</sup>)  
 Factory setting: 100 psi (7 kg/cm<sup>2</sup>)

**Max. lengths of suction line**

**1-pipe system**  
used only when the oil feed is constantly under positive pressure.

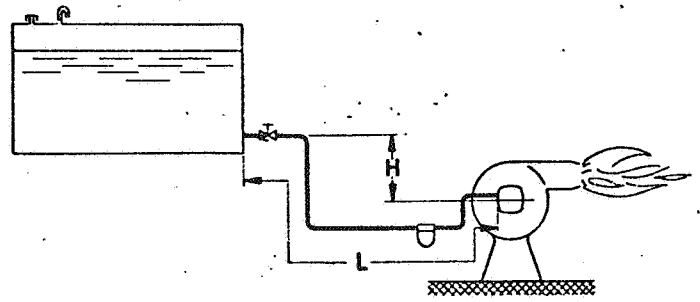
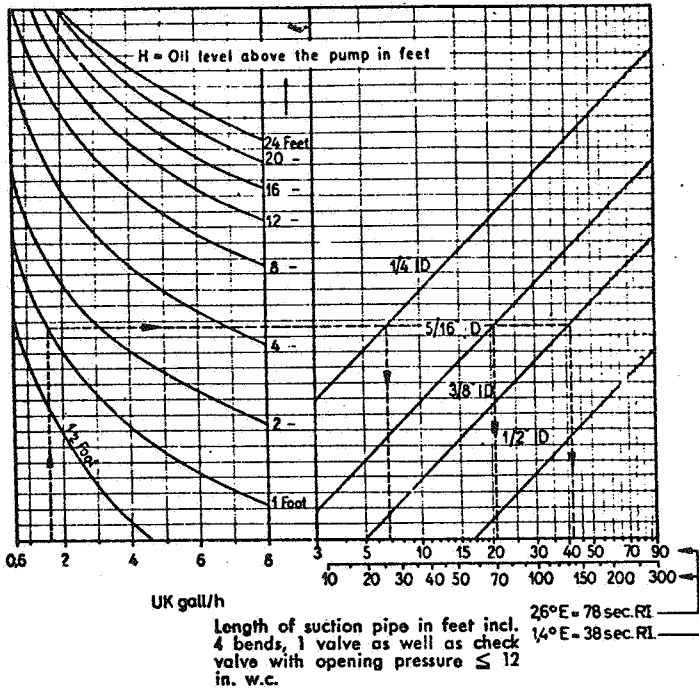

Example: (see dotted lines in diagram).

Nozzle capacity = 1.5 gall/h. Oil level above pump = 1 ft.  
In that case it is possible to use:  
1/4 in I.D. piping max. 7 ft.  
5/16 in I.D. piping max. 21 ft.  
3/8 in I.D. piping max. 40 ft.  
with oil at 78 sec. R 1 (2.6°E).

**2-pipe system**  
used when a vacuum may occur in the suction line.

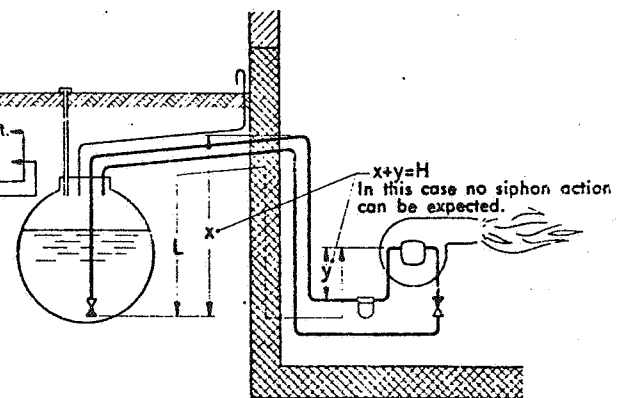
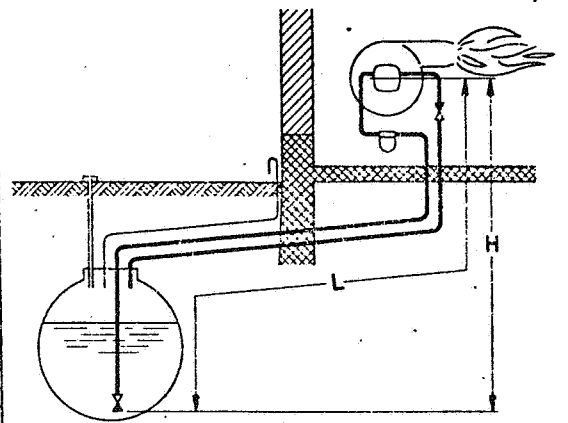
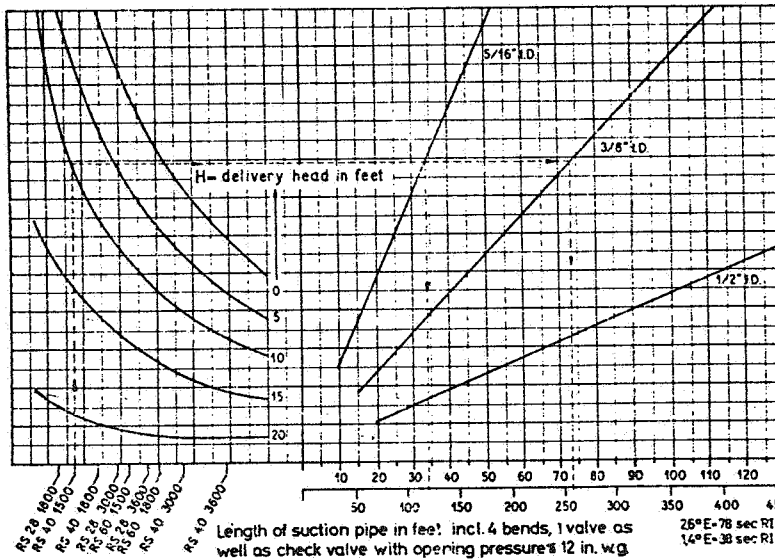

Example: (see dotted lines in diagram).

RS 40 - 1500 rev/min with suction lift H = 10 ft.  
For 78 sec. R 1 (2.6°E) it is then possible to use:  
5/16 in I.D. piping max. 34 ft.  
3/8 in I.D. piping max. 74 ft.  
and with oil at 38 sec. R 1 (1.4°E).  
5/16 in I.D. piping max. 120 ft.  
3/8 in I.D. piping max. 250 ft.

**Ordering Table**

| Type                             | Colour of data plate | Direction of rotation (as viewed towards shaft end) | Code No.           |                    |
|----------------------------------|----------------------|---|--------------------|--------------------|
|                                  |                      |   | Dimension of shaft |                    |
|                                  |                      |   | 10 mm              | 7/16"              |
| RS                               | 28                   | green<br>clockwise<br>anti-clockwise                | 70-5300<br>70L5300 | 70-5310<br>70L5310 |
|                                  | 40                   | blue<br>clockwise<br>anti-clockwise                 | 70-3200<br>70L3200 | 70-3210<br>70L3210 |
|                                  | 60                   | brown<br>clockwise<br>anti-clockwise                | 70-3300<br>70L3300 | 70-3310<br>70L3310 |
| Mounting flange with four screws |                      |   | 70-0211            |                    |

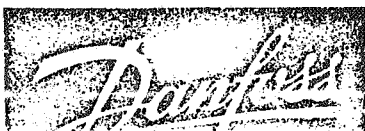



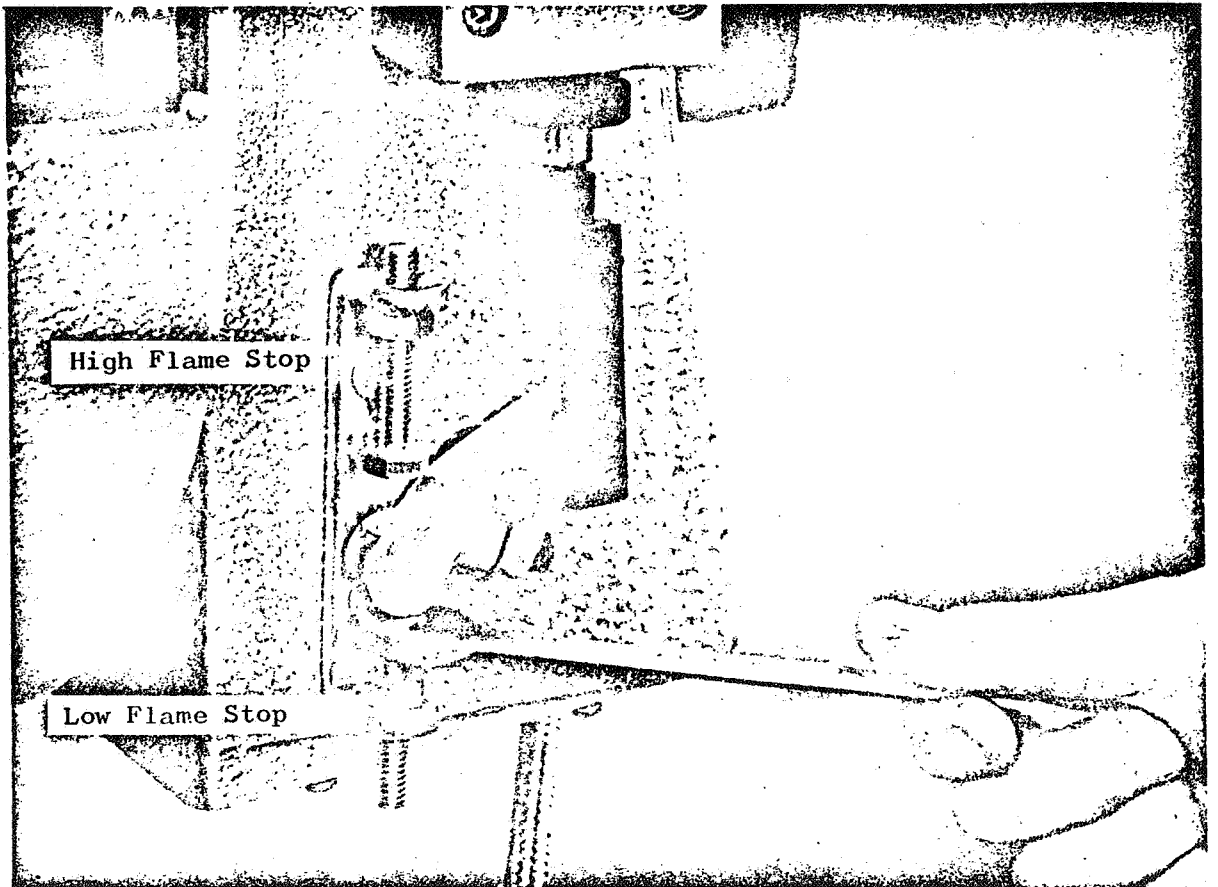

High and low flame adjustment. (See text).

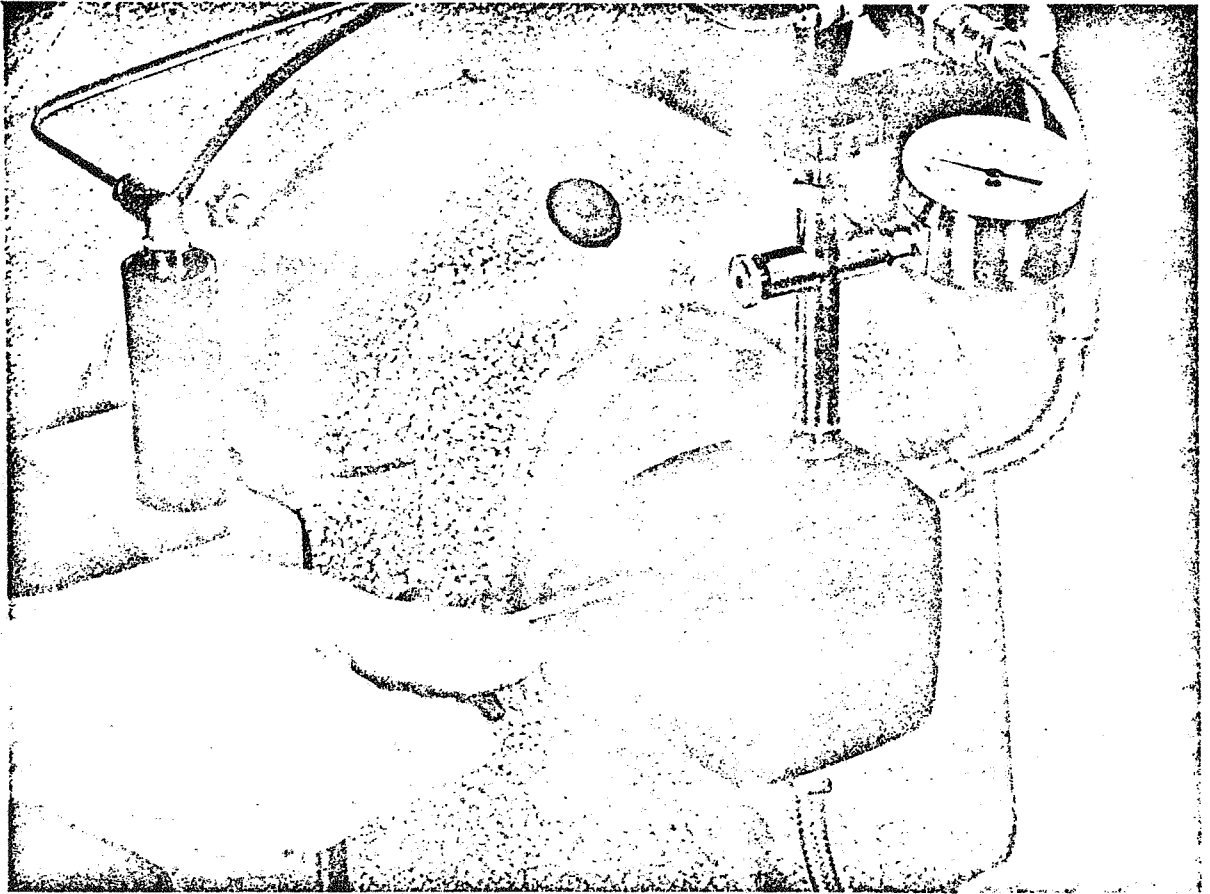

Adjusting oil pressure setting.  
STANDARD 140 P.S.I.

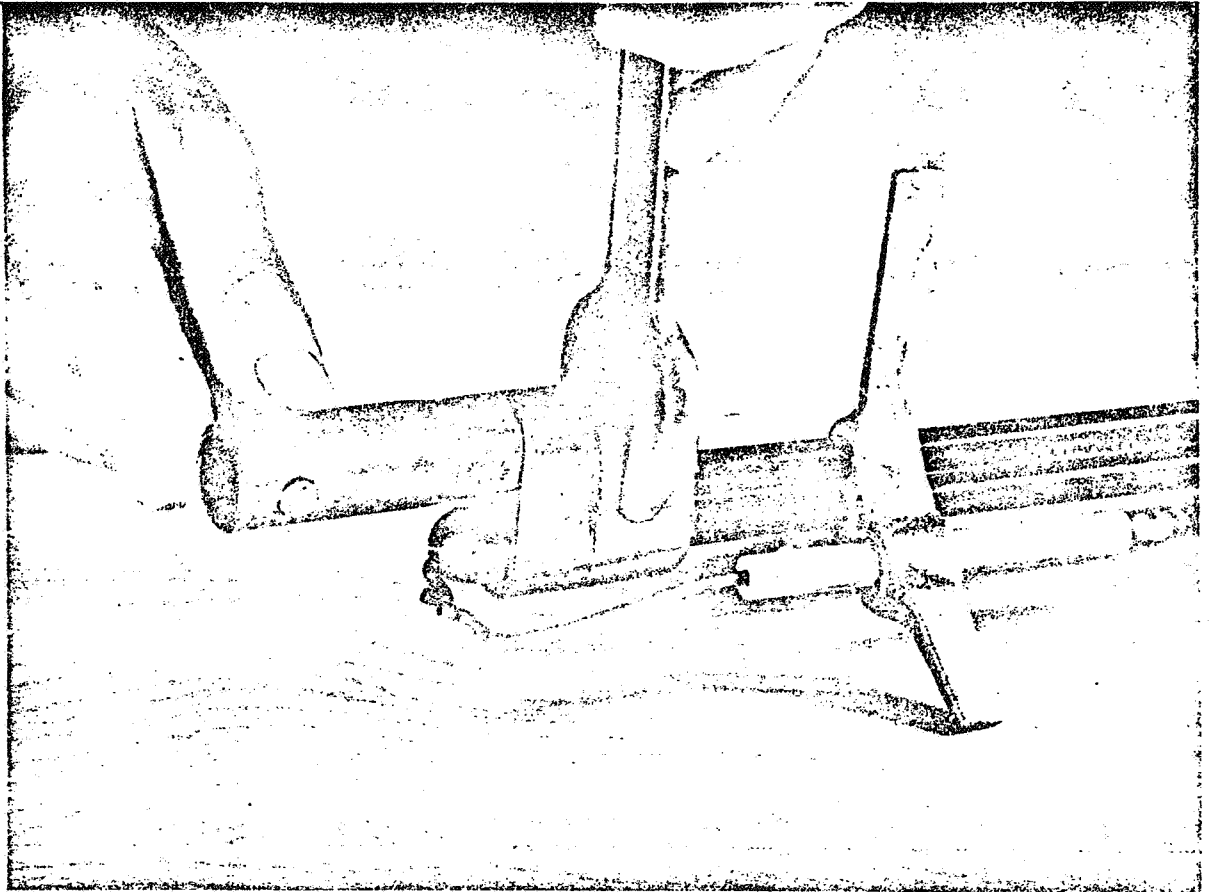

Nozzle(s) can be removed for cleaning using a box spanner  
and open ended spanner.

C 4 S P A R E P A R T S L I S T

|     | <u>DESCRIPTION</u>                          | <u>REFERENCE NUMBER</u> |
|-----|---|-------------------------|
| 1.  | Air Diffuser                                | *                       |
| 2.  | Air Cone/Swirlor                            | *                       |
| 3.  | Draught Tube c/w Air Cone                   | *                       |
| 4.  | Inner Assembly c/w Diffuser                 | *                       |
| 5.  | Nozzle(s)                                   | *                       |
| 6.  | Pump - Danfoss RS 40                        | E02 - 015L              |
|     | Pump - Danfoss RSA60                        | E02 - 043Y              |
| 7.  | Coupling, Motor to Pump                     | G03 - 008P              |
| 8.  | Fan (8.5 dia x 3 $\frac{1}{2}$ " )          | D08 - 005D              |
|     | (9.25"dia x 3.25)                           | D09 - 008R              |
| 9.  | Motor $\frac{3}{4}$ HP 560W 220-240V        |                         |
|     | 1ph 50Hz 2850 RPM                           | A08 - 008K              |
|     | Motor $\frac{3}{4}$ HP 560W 380-440V        |                         |
|     | 3Ph 50Hz 2850 RPM                           | A08 - 013X              |
| 10. | Ignition Transformer                        | <u>C03 - 007D</u>       |
| 11. | Electrode (Pair)                            | G06 - 006G              |
| 12. | Photo-Electric Cell                         |                         |
|     | Landis & Gyr QRB1                           | C31 - 014N              |
|     | Satronic                                    | C31 - 023P              |
|     | Satronic                                    | C31 - 021M              |
| 13. | Sequence Controller                         |                         |
|     | Landis & Gyr LAB 1                          | C21 - 030Y              |
|     | Landis & Gyr LAC 1.035                      | C21 - 036J              |
|     | Satronic TF1 701B                           | C21 - 053T              |
|     | Satronic TMO 720                            | C21 - 059H              |
| 14. | Filter Complete                             | E03 - 031K              |
|     | Element only                                | E03 - 025P              |
| 15. | Flexible Oil Pipe 24" x $\frac{1}{4}$ " BSP | E05 - 003U              |
| 16. | Flame Viewing Window                        | G16 - 007S              |
| 17. | Hydraulic Cylinder                          | E19 - 001X              |
| 18. | Contactoer Danfoss CU10                     |                         |
|     | (3Ph only)                                  | C56 - 003D              |

C03 - 012Z

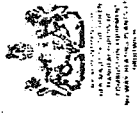

C4  
C4-H/L

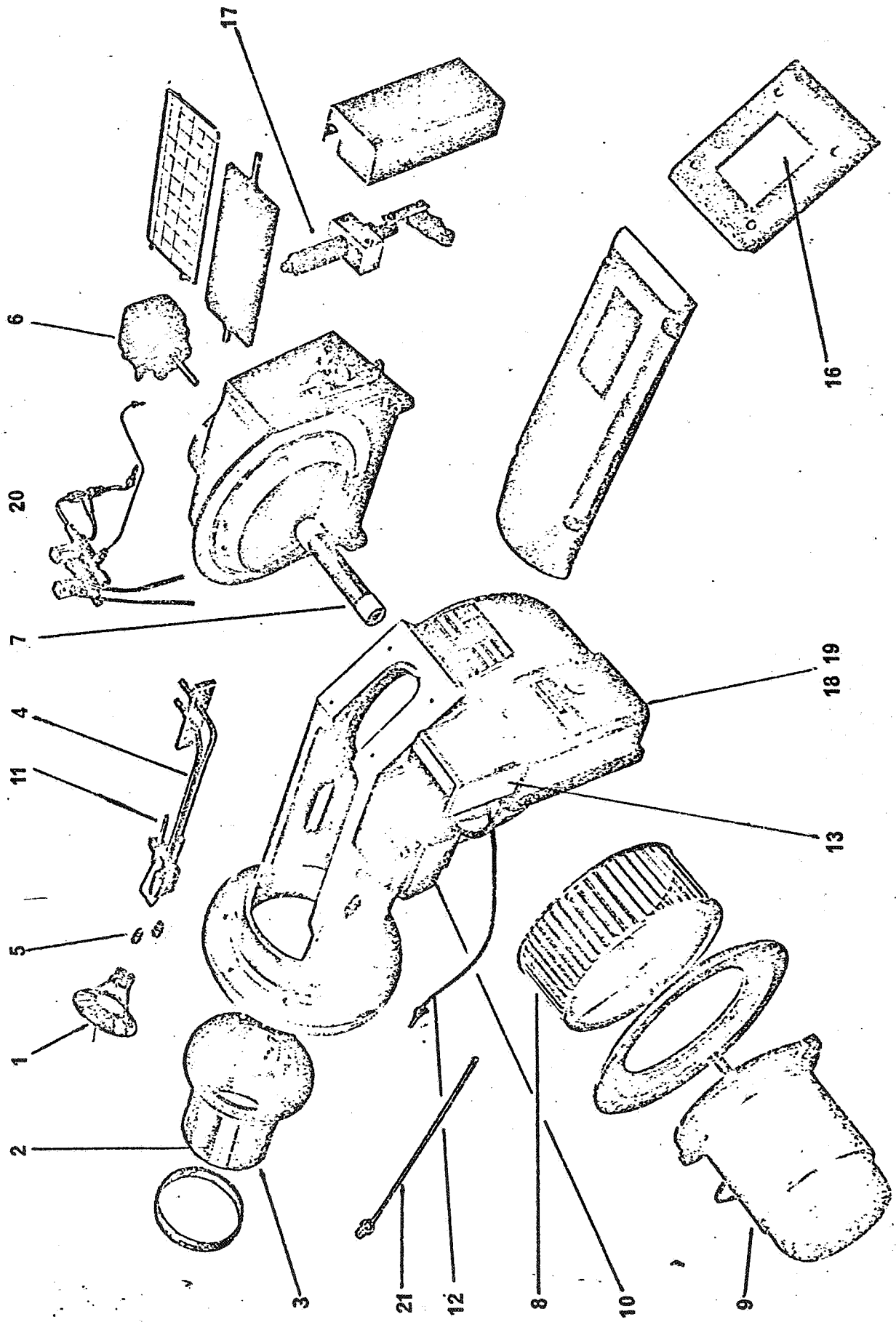

distort diffuser.

Clean air handling parts as illustrated taking care not to

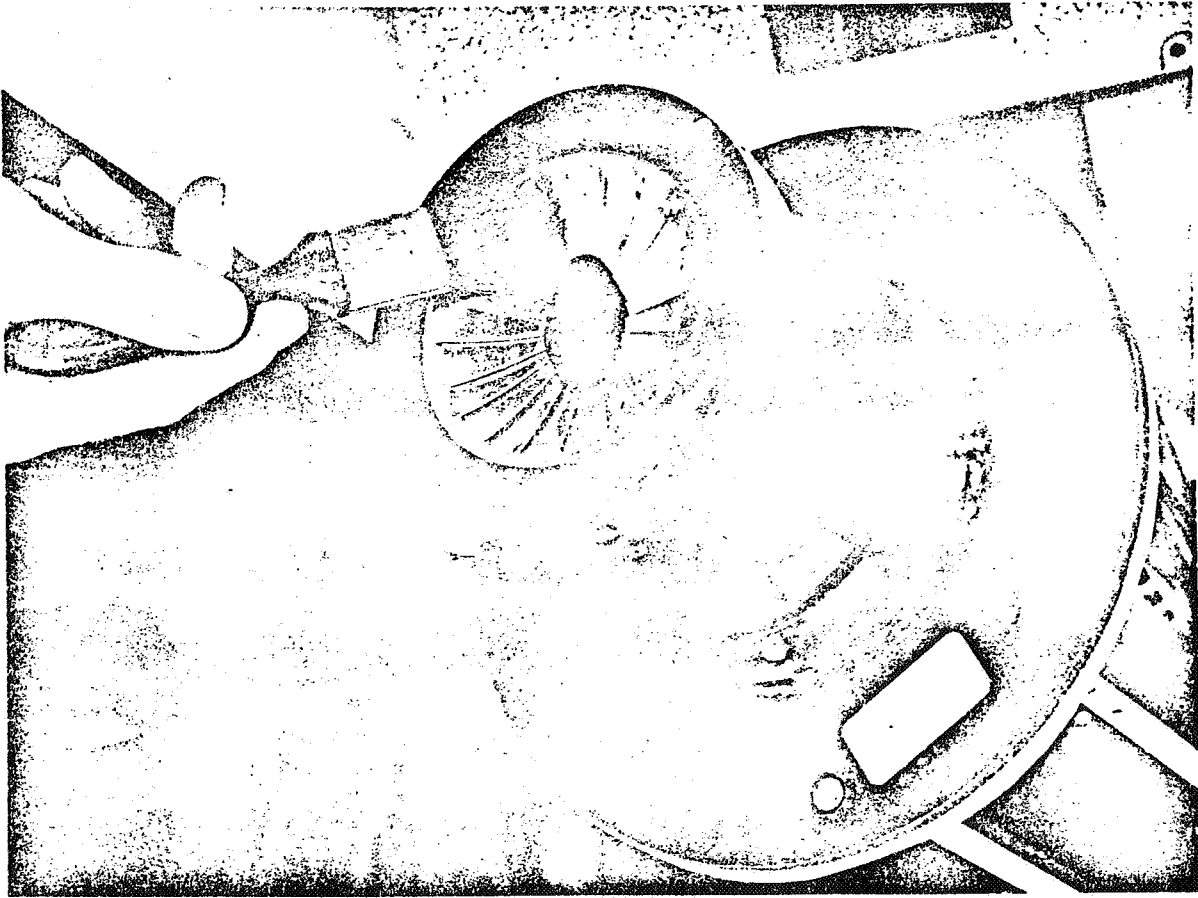

Keep fan blades free from oil and dust.  
Use soft brush as  
illustrated to clean.

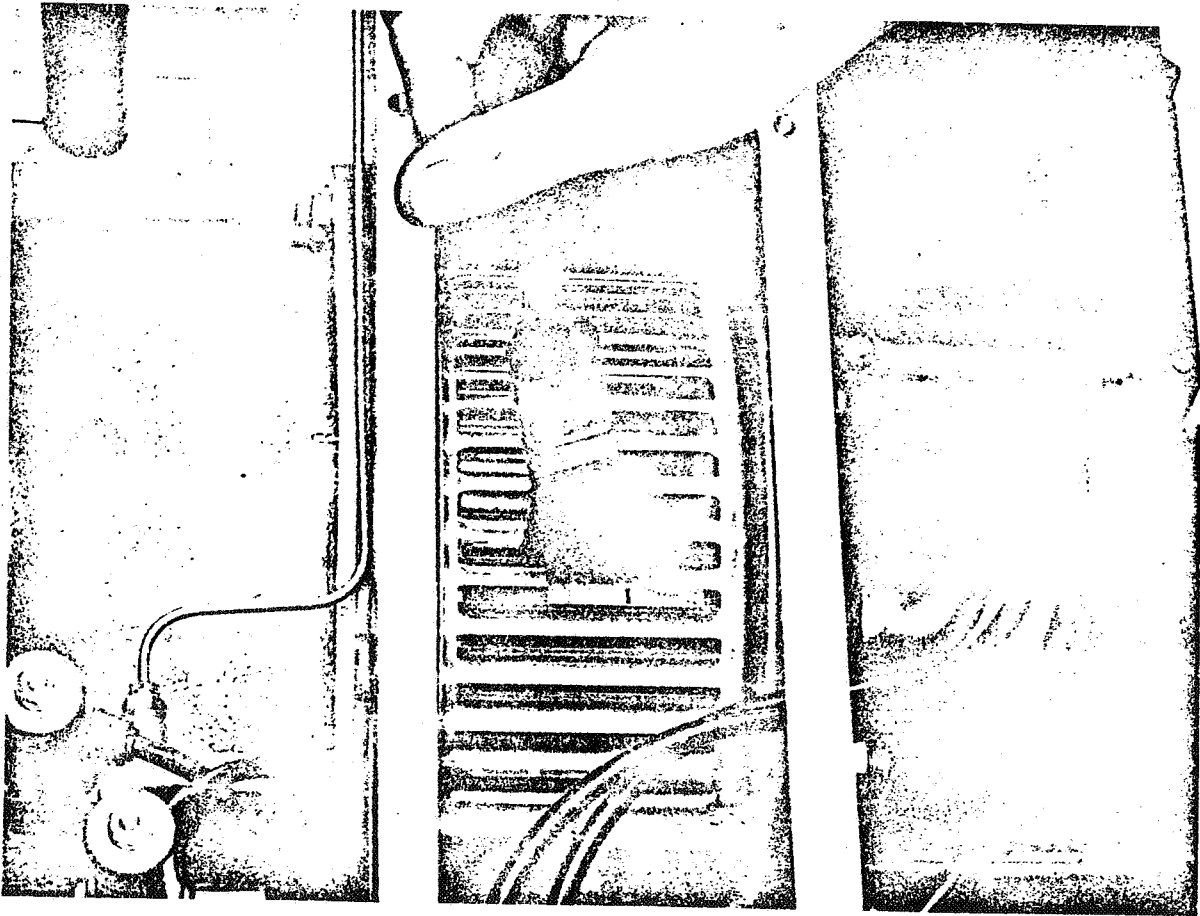

by a straight pull.

Withdraw inner assembly after detaching H T Lead connectors

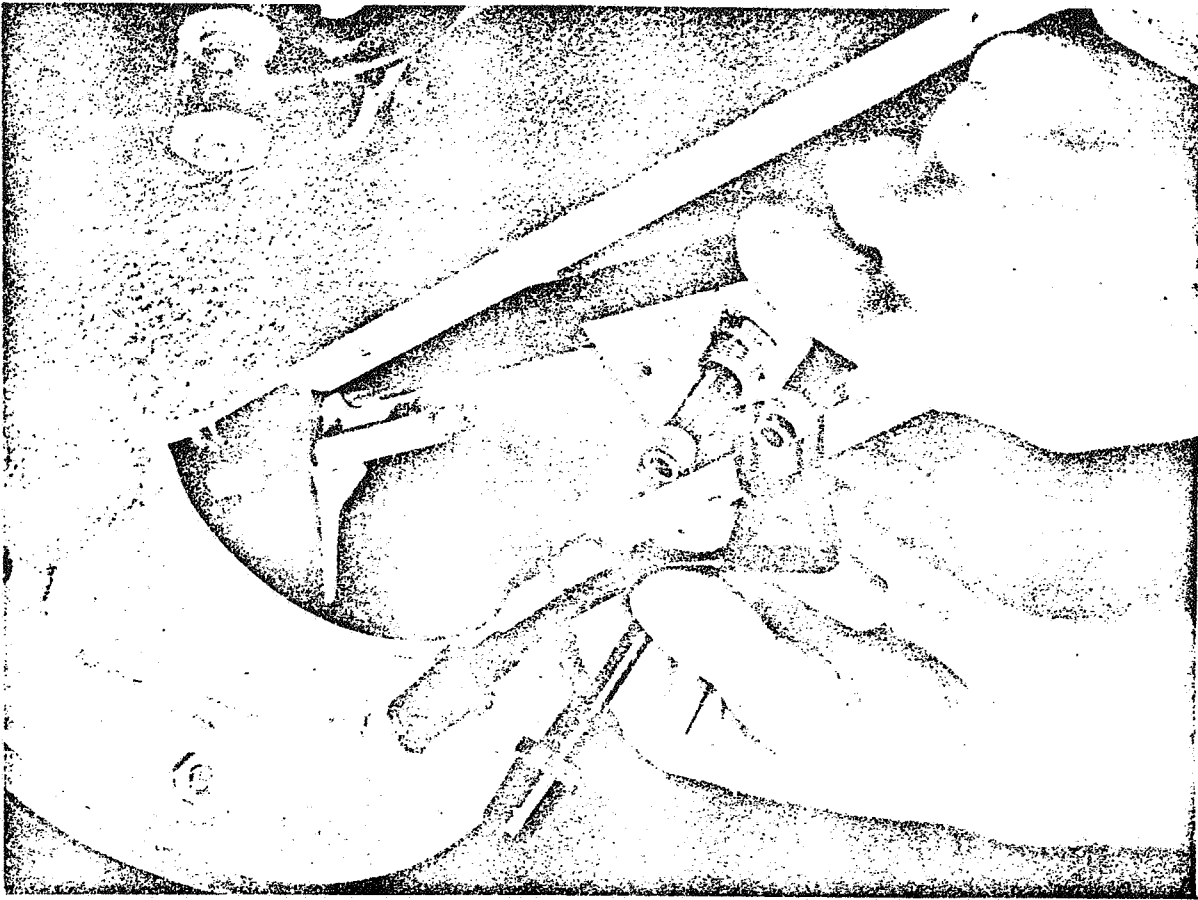

fan casing while supporting inner assembly.

To remove nozzle assembly remove the two screws at side of

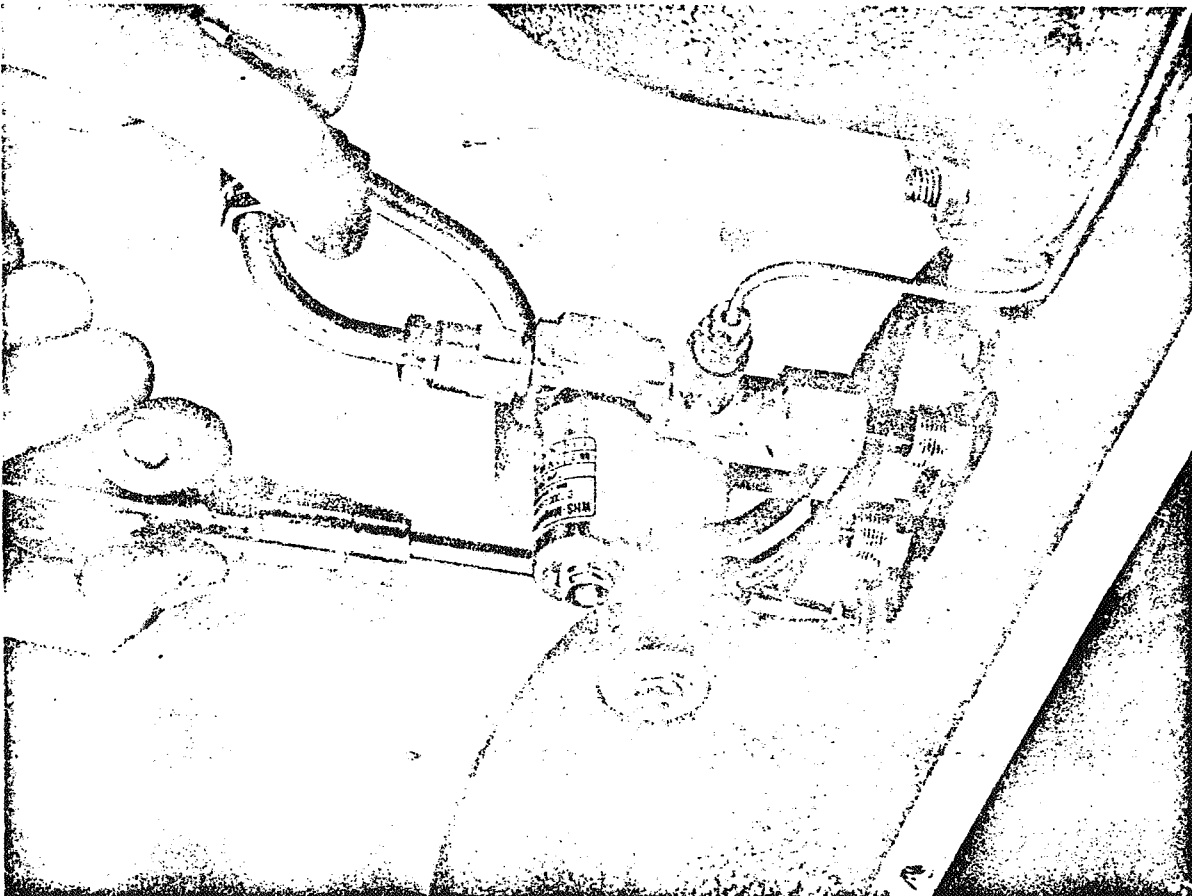



C 4 S P A R E P A R T S - L I S T

|     | <u>DESCRIPTION</u>                           | <u>REFERENCE NUMBER</u>  |
|-----|--|--------------------------|
| 19. | Overload Protection - Danfoss<br>(3Ph Only)  | C55 - 035T               |
|     | Overload Protection<br>(1PH Only)            | C55 - 035T               |
| 20. | Solenoid Valve Complete<br>(W.H.S.)<br>VENTO | E01 - 0287<br>E01 - 033M |
| 21. | Ignition Lead Complete<br>With Connectors    | *                        |

\* Burner specification number (on burner data plate) is required when ordering these spares.