

Installation & Maintenance Manual

Series NO fully automatic oil burner Models NOE/NOF & NOG 18-25 to 100-38

Oil Burner

CAPACITY

The Nu-way NOE/F/G 18-25 to NOE/F/G 100-38 pressure jet burners are designed for automatic High/Low/Off operation with burner outputs from 147-2940 kW (125,391-2,500,000 kcal/h; 501,564-10,000,000 Btu/h).

The burner will fire pressurised boilers with high resistances as listed on the burner selection graph.

For other applications please consult our technical sales department.

CONSTRUCTION

All burners are of a monobloc design, suitable for flange mounting.

The mounting flange is hinged to allow access to the burner head for ease of maintenance and service.

AIR REGULATION

Air control is by (letter box) single blade damper, hydraulically operated on NOE and NOF versions.

NOG burners have the damper electrically motorised.

The NOG burners also have a fully closing damper which closes the air damper when the burner is not operational. This enables the appliance to be kept at the highest possible temperature during shutdown periods, while the oil pumping/heating system is in intermittent operation, to maintain the fuel oil at atomising temperature ready for immediate restart.

CONTROLS

The NOE/F/G burners may be controlled by suitable thermostats, pressure switches, etc.

Burners are supplied complete with a pre-wired control panel.

FUELS

Maximum viscosities are as follows:-

NOE Class E - 8 cSt at 100 °C

NOF Class F - 20 cSt at 100 °C

NOG Class G - 40 cSt at 100°C

SAFETY FEATURES

Flame supervision by photo- electric cell with synchronous sequence controller for automatic start-up, running and shutdown of the burner.

OPTIONAL EXTRAS

- ⇒ Modulating flame control operation for burner outputs 600 kW and above (see separate manual).
- ⇒ Air inlet silencer
- ⇒ Sound shield wheel-over acoustic cover

Contents

	Page
1. INTRODUCTION	5
General	5
Safety	5
2. BURNER	6
Assembly	6
Fitting to the Appliance	7
Flue & Chimney Requirements	7
Combustion Chamber Conditions	7
Plant Room Ventilation	7
3. SITE SERVICES	7
Electrical Power Supply	9
Oil Supply	9
Main Oil Storage Tank	9
Oil Supply to the Burner	9
Pumped Ring Main System	10
Oil Temperature for Residual Oil	10
Burner Pump Capacities	10
4. BURNER OIL ATOMISING SYSTEMS	11
Models NOE & NOF with Hydraulically Operated Air Damper	12
Air Control Damper	12
Air Diffuser	13
Primary Air Tube	14
Restrictor Ring	14
Adjustment of Berger LAHR (Air Regulator) Motor Cams	14
Sequence of Operation	15
To Adjust	15
Instructions for 'Factory Setting' of Berger Motor, or Fitting of Replacement Motor	16
To Set	16
Berger LAHR Motor and Air Damper Position Indicators	16
Burner Oil Components	17
Inner Assembly	17
Nozzle Block	17
On/Off Low Fire Spring Loaded Piston Cut-off Valve	17
High Fire Hydraulic Spring Loaded Piston Cut-off Valve	17
Oil Nozzle	18
Ignition Electrodes	18
Oil Manifold Block	18
Magnetic Valve and Manifold Unit	18
Magnetic Valve (two-way)	18
Magnetic Valve (three-way)	19
Oil Preheater Tank	19
Oil Pump	19
Microswitch	19
Oil Circulation Thermostat	19
Control Panel	20

5.	PRE-FIRING CHECK AND INITIAL SETTINGS	20
	Pre-commissioning	20
	Commissioning	20
	Pre-Heater Thermostat Settings	21
	Pre-Purge of Burner Fuel System	21
	Starting – Low Fire	22
	High Flame Operation	22
	Checking the Sequence Controller	23
6.	ROUTINE MAINTENANCE	24
	Ignition Electrodes	24
	Air Diffuser	24
	Nozzles	24
	Photocell	25
	Cold Oil Filter	25
	Hot Oil Filter	25
7.	FAULT FINDING	25
	Burner Motor Fails to Start	25
	Fan Starts – No Flame – Burner goes to Lockout	25
	Burner Starts – Fails to Run	26
	Burner Starts – Fails to Change to High Flame	26
8.	SPARE PARTS IDENTIFICATION	26

ILLUSTRATIONS	Page
Electrical Data	4
Dimensions	4
Completely Assembled Package	Fig 1. 5
Connecting HT Leads	Fig 2. 6
Cartridge Heater and Thermostat Connections	Fig 3. 6
Connecting Self-Sealing Quick Release Couplings	Fig 4. 6
Fuel Connections to Burner Unit	Fig 5. 6
Oil System Diagrams NOE Burners	Fig 6a. 7
Oil Systems Diagrams NOF Burners	Fig 6b. 8
Oil Systems Diagrams NOG Burners	Fig 6c. 8
Ring Main System for Residual Oil Burners	Fig 7. 9
Oil Circulation with Hydraulically Operated Damper	Fig 8. 11
Oil Circulation with Electrically Operated Damper	Fig 9. 12
Air Control Damper and Adjustable Stops fir Hydraulic Air Settings	Fig 10. 13
Head Arrangement for High/Low Burners	Fig 11. 13
Cam Setting for Berger LAHR Motor	Drg. WA47389 14
Connections for Berger LAHR Motor	Drg. WA46996 16
Air Damper Position Indicators	Fig. A and B 17
Low and High Flame Piston Cut-off Assemblies	Fig 12. 17
Pre-heater Tank Thermostats	Fig 13. 19
Timing Chart for Control Boxes	Fig 14. 21
Ignition Electrode Settings	Fig 15. 24

DIMENSIONS

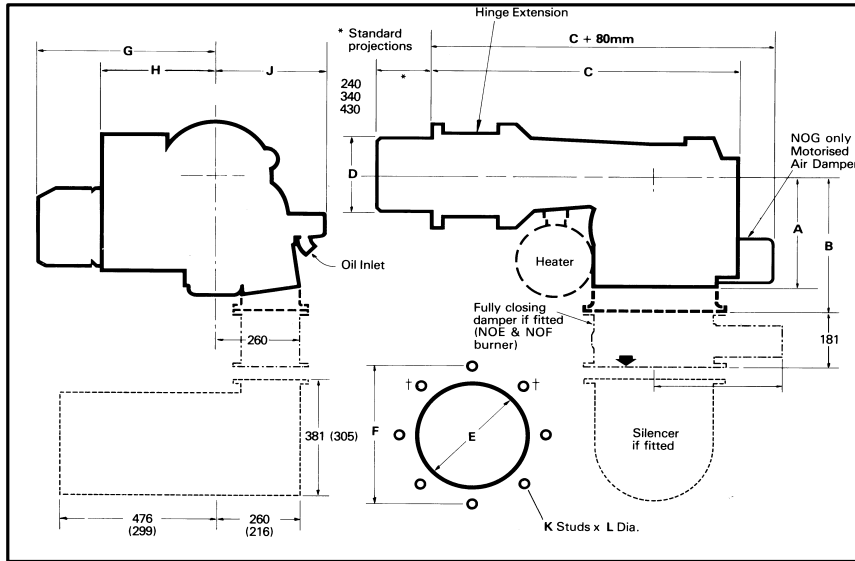

These dimensions are intended for general assessment of the overall sizes of the burners and should not be used without reference to our Technical Department or inclusion in drawings for installation purposes. Certified dimensional drawings are available on request on receipt of orders.

BURNER MODEL	A	B	C	D	E	F	G	H	J	K	L	Weight kg
NOG 18-12	314	-	785	178	205	254	352	340	315	8	M10	115.0
NOG 18-34	387	440	978	182	230	305	420	340	337	8	M10	115.1
NOG 18-38	-	480	1029	182	230	305	457	340	350	8	M10	129.0
NOG 35-25	314	-	785	178	205	254	352	340	315	8	M10	115.0
NOG 35-34	387	440	978	182	230	305	420	340	337	8	M10	115.1
NOG 35-38	-	480	1029	182	230	305	457	340	350	8	M10	129.0
NOG 50-28	387	440	978	223	254	305	420	340	337	8	M10	110.5
NOG 50-34	387	440	978	223	254	305	457	340	337	8	M10	112.4
NOG 50-38	-	480	1029	223	254	305	480	340	350	8	M10	129.0
NOG 60-28	387	480	978	223	254	305	457	340	337	8	M10	110.5
NOG 60-34	387	440	978	223	254	305	480	340	337	8	M10	112.4
NOG 60-38	-	480	1029	223	254	305	480	340	350	8	M10	129.0
NOG 85-38	-	480	1029	254	280	305	537	490	365	8	M10	145.0
NOG 100-38	-	480	1029	254	280	305	537	490	365	8	M10	145.0

ELECTRICAL DATA

All data calculated at 415 volts. All motors are 2 pole, 2800 rpm.

BURNER MODEL	FAN MOTOR		PRE-HEATER	START CURRENT	RUN CURRENT	CABLE SIZE	HRC FUSE
	kW	hp	kW	A phase	B phase	mm ²	A
NOG 18-12	1.2	1.5	3.0	19.2	6.7	1.5	20
NOG 18-34	2.2	3.0	3.0	29.2	8.8	1.5	15
NOG 18-38	3.0	4.0	3.0	39.2	10.3	2.5	20
NOG 35-25	1.1	1.5	4.5	21.3	8.8	1.5	20
NOG 35-34	2.2	3.0	4.5	31.3	10.9	2.5	20
NOG 35-38	3.0	4.0	4.5	41.3	12.6	2.5	20
NOG 50-28	2.2	3.0	6.0	33.4	13.0	2.5	25
NOG 50-34	3.0	4.0	6.0	43.4	14.5	4.0	30
NOG 50-38	4.0	5.5	6.0	53.4	16.4	4.0	30
NOG 60-28	3.0	4.0	6.0	43.4	14.5	4.0	30
NOG 60-34	4.0	5.5	6.0	53.4	16.4	4.0	30
NOG 60-38	4.0	5.5	6.0	53.4	16.4	4.0	30
NOG 85-38	5.5	7.5	7.5	50.5	22.0	6.0	30
NOG 100-38	7.5	10.0	9.0	72.5	26.9	10.0	40

1. INTRODUCTION

The manual covers three types of burner:-

Models NOE 18-25 to 100-38 High/Low Burners (Class E Fuel)

Models NOF 18-25 to 100-38 High/Low Burners (Class F Fuel)

Models NOG 18-25 to 100-38 High/Low Burners (Class G Fuel)

Where an instruction or information is applicable to only one of the burner types, then it is identified in the text.

The NOF/F/G high/low burners operate on a High/Low/Off flame basis.

FIG. 1



GENERAL

This manual is structured to enable the user to proceed from the delivery of the burner to its commissioning and use.

Burner assembly, components, controls used and adjustments to be made are dealt with in a sequence that should be followed for correct assembly, installation and use.

Pre-Commissioning and Live Run are described and the locations of components are illustrated and supported by appropriate tabulated information and graphs.

Routine Maintenance, Fault finding and Spare Parts identification complete the manual.

SAFETY

Before attempting to assemble, install or commission the Nu-way NOE, NOF or NOG burner series, it is essential that the following instructions are carefully read and understood. It is also recommended that such work is carried out only by experienced and qualified oil burner commissioning engineers.

The manufacturer cannot be held responsible for any consequential damage, loss or personal injury as a result of customers failing to follow these instructions, or as a result of misuse.

2. BURNER

Assembly – Mode Two

At this stage it may be more convenient to fit the hinged extensions / flame tube assembly to the appliance before attaching the burner body. Ensure the gasket provided is fitted between the appliance and mounting flange.

Alternatively the hinged extension may be attached to the burner body and the complete burner assembly then fitted to the appliance. Ensure the gasket provided is fitted between the appliance and mounting flange.

The hinged extension is fitted to the burner body with the 8 studs and nuts provided. Ensure the oil manifold block is at the bottom (Fig 1).

Open the hinged extension and connect the ignition leads to the electrodes. Close the hinged extension (Fig 2).



FIG. 2

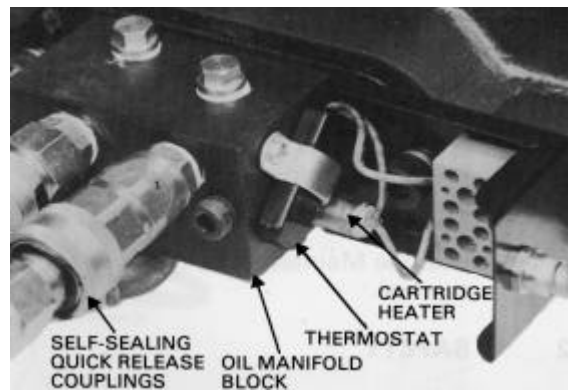

FIG. 3

Connect the cartridge heater and thermostat socket lead to the plug located in the oil manifold block terminal box. Secure the terminal box cover (Fig 3).

Connect the self-sealing quick release flexible oil pipes between the magnetic valve manifold block and the oil manifold block (Fig 4).

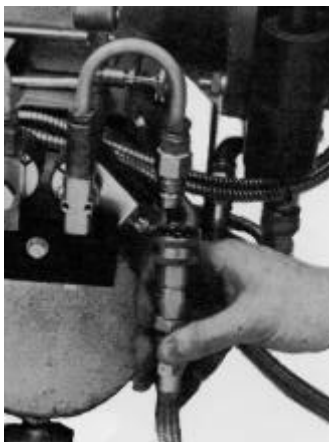

FIG. 4

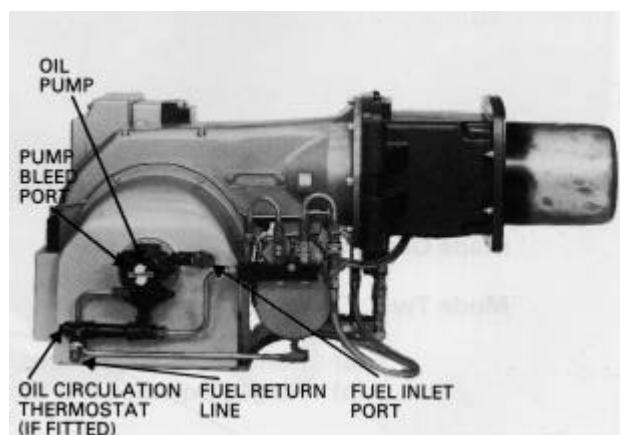

FIG. 5

Connect the flexible oil pipes from the oil inlet and return ports on the burner to the main oil supply pipework (Fig 5).

Check that the main oil filter is installed correctly (Fig 6).

Burner	Inlet Size	Return Size
NO50-28, NO18-34 NO 35-34, NO 18-38 NO 35-38, NO 50-38	½" BSP	¾" BSP
NO 80-34 NO 85-38, NO 100-38	¾" BSP	¾" BSP

FITTING TO THE APPLIANCE

If the burner is to be fitted to a new packaged unit with over-pressure conditions, refer to the Manufacturer's recommendations.

If the burner is to be used with an existing appliance, the chimney, flues, passage-ways and heat transfer surfaces must be cleaned. Prepare burner mounting plate (see dimensional drawing in data sheet). Ensure that the joint between the appliance and the burner is effectively sealed by using the gasket provided.

Flue and Chimney Requirements

The top of the chimney / flue should be above all roofs within a radius of 10 metres.

Ensure that the flue pipe from the appliance does not protrude into the chimney beyond the wall thickness.

If more than one appliance is connected to a common flue / chimney, ensure that the cross-section of the flue / chimney is adequate for the total volume of flue gases from all the appliances, and complies with Local Regulations.

It is recommended that each appliance should be exhausted into a separate flue.

Combustion Chamber Conditions

When the burner is fitted to an appliance designed to work under balanced or negative combustion chamber conditions, the over fire draught must not exceed 0.05 kPa (0.2 inches wg, 0.5 mbar, 5mm wg).

Should the over fire draught exceed this figure, then steps should be taken to reduce it to this level.

Plant Room Ventilation

An adequate dust-free supply of fresh air is required for the burner at both high and low level in accordance with the appropriate standards.

3. SITE SERVICES - FIG 6A

OIL SYSTEM DIAGRAM NOE BURNERS

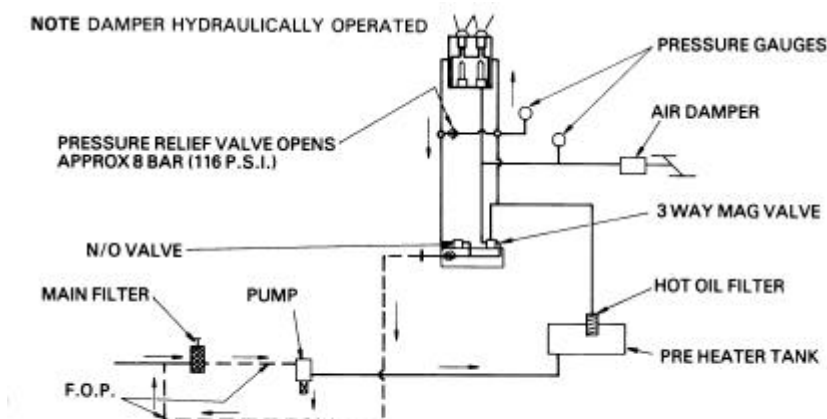

OIL SYSTEM DIAGRAM NOF BURNER – FIG. 6B

A4-2483

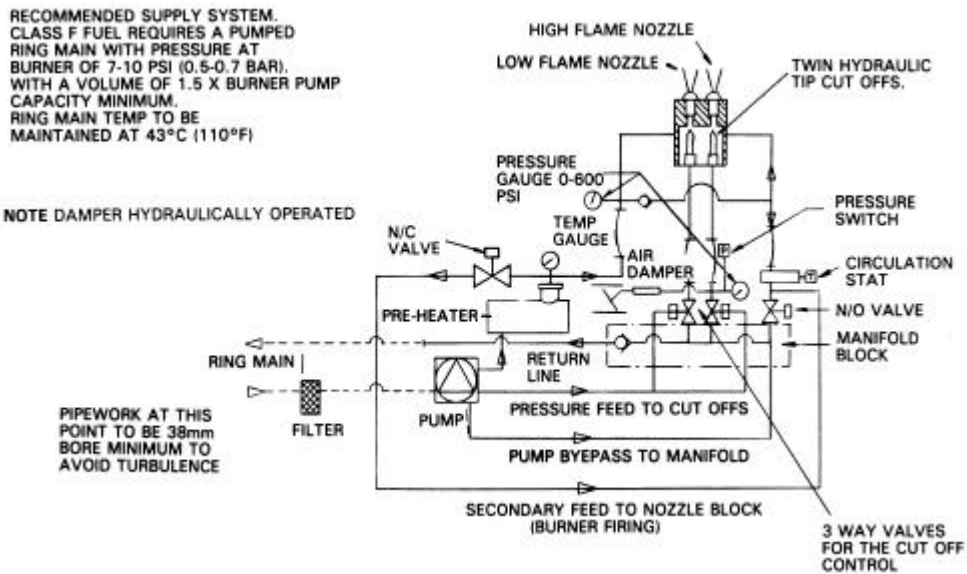

OIL SYSTEM DIAGRAM NOG BURNER - FIG 6C

A4-2482

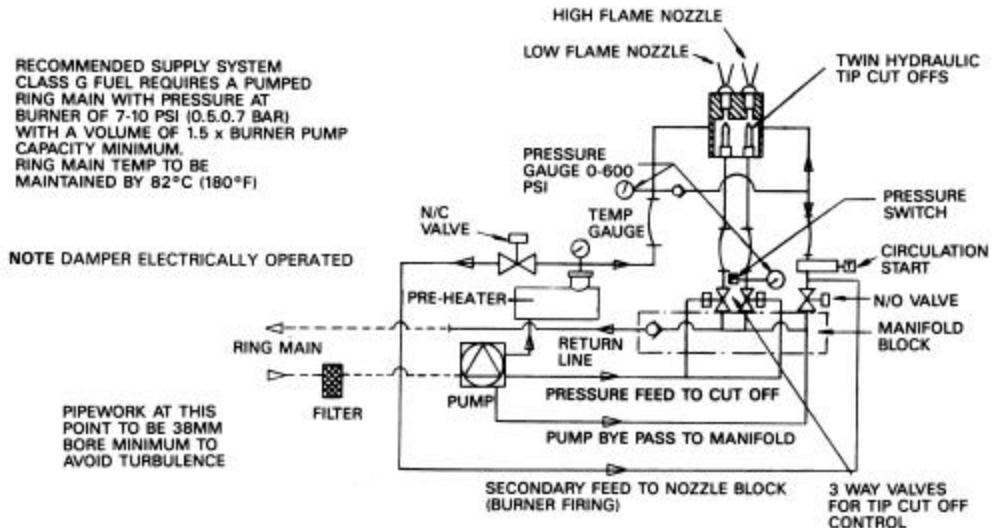

SUPPLEMENT TO HANDBOOKS

SPECIFICATION CHANGES

NEW WIRING COLOURS

In accordance with the Requirements for Electrical Installations BS 7671:2001 Amendment No 2 (the IEE wiring regulations), wiring colour coding has been amended to Brown (L) and Blue (N) for single phase power circuits and Brown (L1) Black (L2) and Grey (L3) and Blue (N) **in three phase power circuits** from 1 June 2006.

Full details of the changes can be found in Amendment No 2 (AMD 14905) to BS 7671:2001 - which is a free download from the IEE website (www.iee.org/cablecolours). They are also within the new version of BS7671:2001 (Incorporating Amds 1& 2) published on 31st March; this new version of the Wiring Regulations can be identified by its brown cover.

ELECTRICAL POWER SUPPLY

Connect the appropriate electricity supply to the burner observing all applicable Codes and Standards. Refer to specific burner wiring diagrams that are supplied with the burner or the appliance manufacturer's handbook. Connect external auxiliary control circuits by reference to the appropriate wiring diagrams. Check all systems and circuits are correctly fused.

OIL SUPPLY

All oil supply systems must be of an insulated pressurised ring main type as shown in Fig. 7.

Main Oil Storage Tank

Residual oils must be maintained at all times to a temperature specified by the Oil Supplier. (See 'Oil Temperature For Residual Fuel' table). For details of oil storage tank sizing. Design and installation, please refer to our technical sales department.

Oil Supply to the Burner

Oil from the tank to the burners should be supplied by pumped ring main system, Fig. 8) at the correct temperature and pressure.

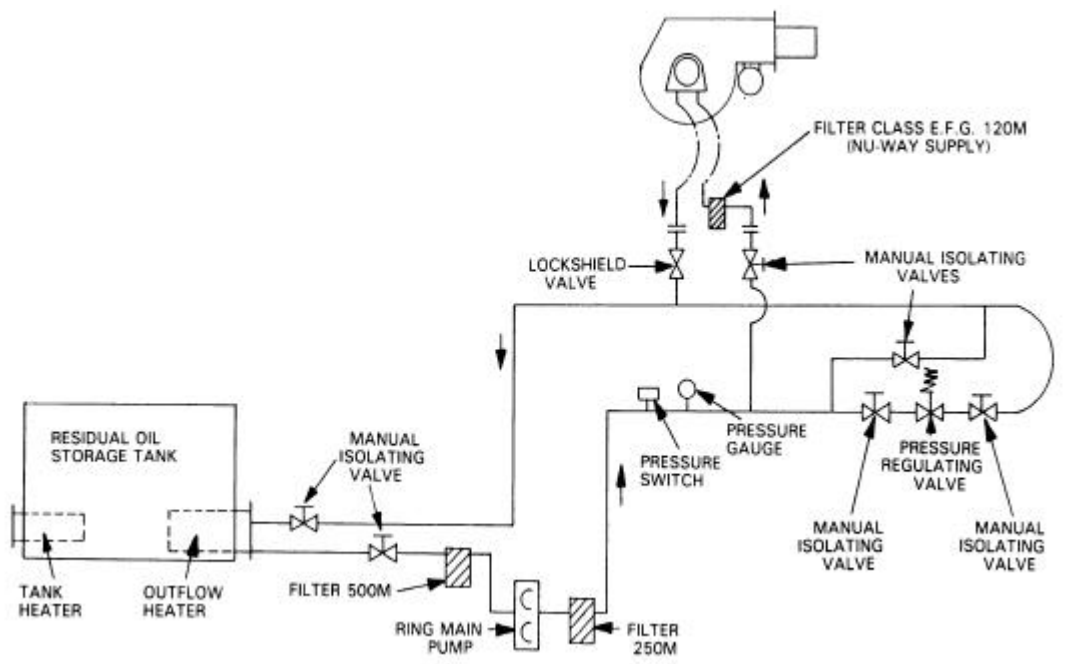

FIG.7 Suggested Ring Main for Residual Oil High/Low Burners. Ref. A4-2323

PUMPED RING MAIN SYSTEM

An oil ring main system is essential for reliable burner operation.

Multiple burner installations require careful flow balancing to ensure oil flow in all sections of the oil system.

The ring main pumps and pipe size must be designed to give 1.33 times the total full swept volume of the burner pumps/pumps it is to supply. (See table for Burner Pump Capacities below).

All oil supply pipes must be constructed and installed to comply with local conditions and appropriate does and standards. All pipework must be firmly supported, lagged, traced and the oil flow operated thermostatically controlled.

Single Pipe Gravity Feed Oil Supply must NOT be used.

OIL TEMPERATURE FOR RESIDUAL FUEL

Fuel Class BS 2869 1970	Max Fuel Viscosity at 100°C in cSt	Minimum Storage Temperatures		Temperature required at Burner Unit		Atomising Oil Temperature	
		°C	°F	°C	°F	°C	°F
E	8	10	52	16	60	82	180
F	22	25	77	43	110	110	220
G	40	40	104	83	181.5	143	290

BURNER PUMP CAPACITIES

BURNER TYPE NOE, NOF & NOG	TOTAL CAPACITY Litre/Hour
NO 18025 TO NO 60-38	250
NO 85-38 NO 100-38	379 379

4. BURNER OIL ATOMISING SYSTEMS

The system of pressure atomisation is used throughout the range. The method of operation is the well-proven two-stage (high/low) constant pressure twin nozzle system. Each nozzle is controlled by a pressure operated cut-off valve integral with the nozzle block assembly. The burner air control device takes the form of a single air damper blade with operating linkage and simple adjustment for high and low air setting. The operation of the air control device is by a pressure operated hydraulic system. For Models NOE (Fig 8) or Berger LAHR servomotor for model NOG (Fig 9).

3-Pipe System - NOE Burners

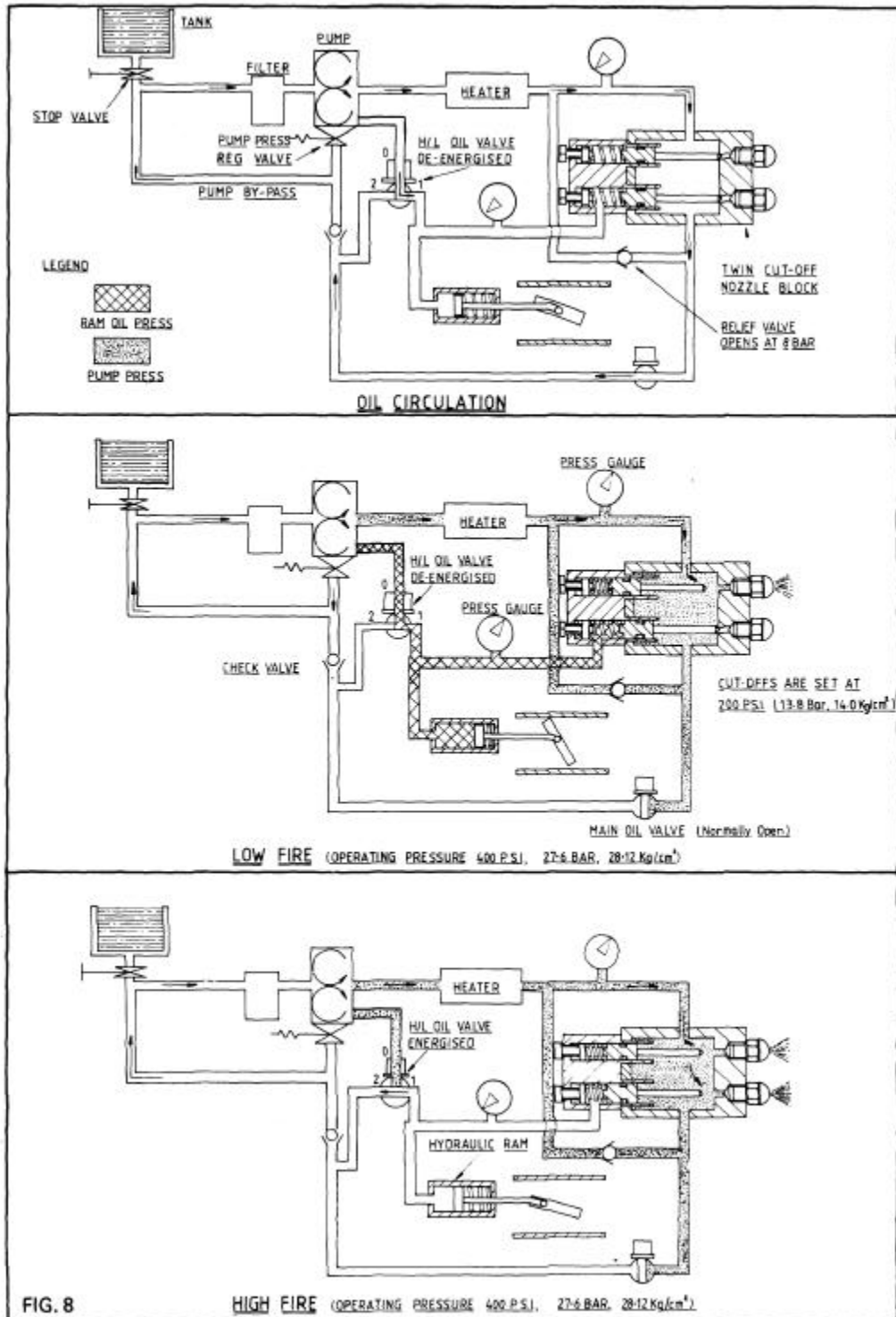

Model NOG for Class G fuel is based on the principle outlined except the air control device is operated by an electric servomotor with an inlet fully closing air damper which closes the air supply during the burner "off" periods.

**4-Pipe System - NOF (Hydraulic Air control) Burners
NOG (Electric Air control) Burners**

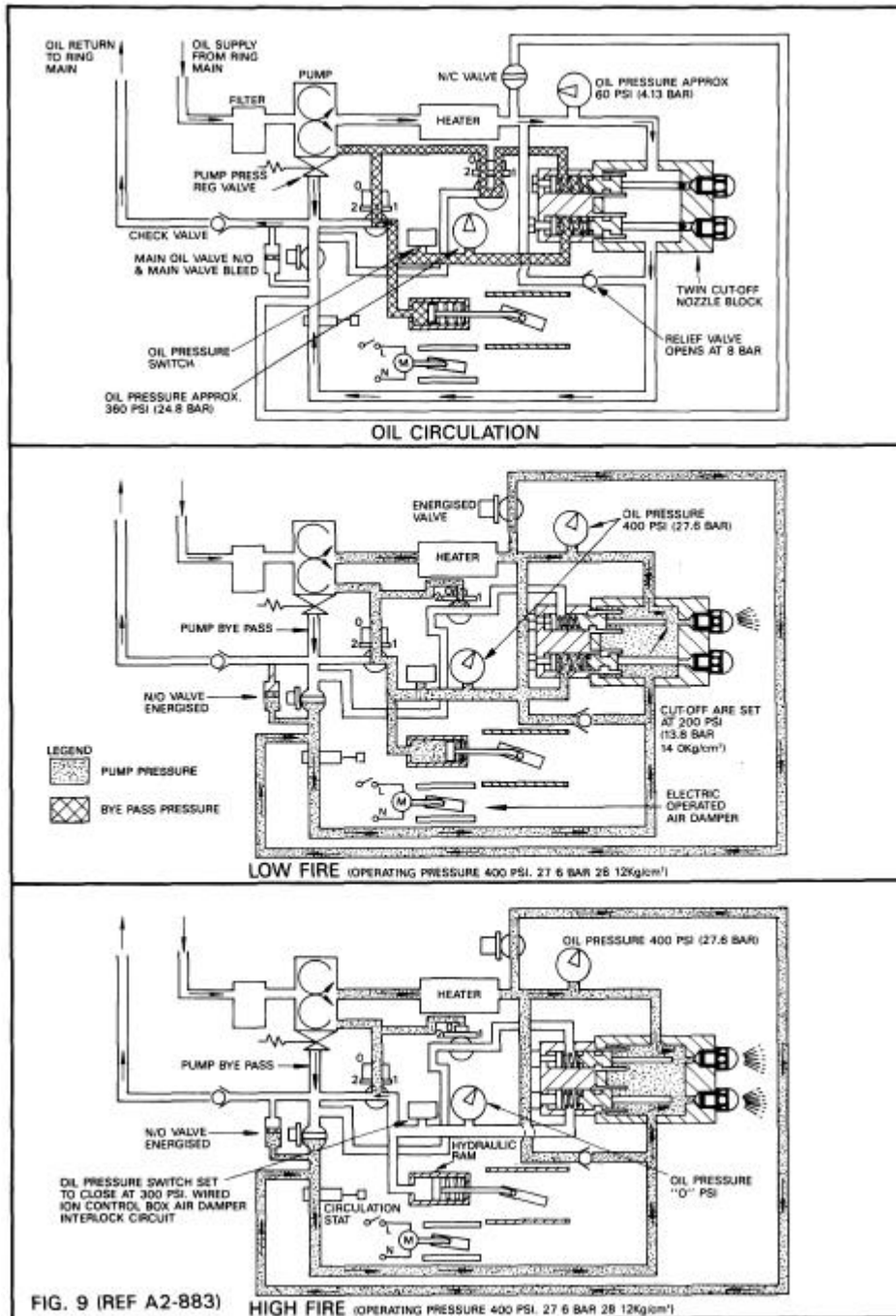

MODELS NOE & NOF WITH HYDRAULICALLY OPERATED AIR DAMPER

Air Control Damper (Fig 10)

Located inside the air inlet to the burner, its purpose is to control air flow of the combustion air. To achieve accurate repeatable performance of the burner.

Adjustable stops and the hydraulic ram for setting high and low flame air positions are located beneath the cover on the rear of the inlet casing. (Fig 10)

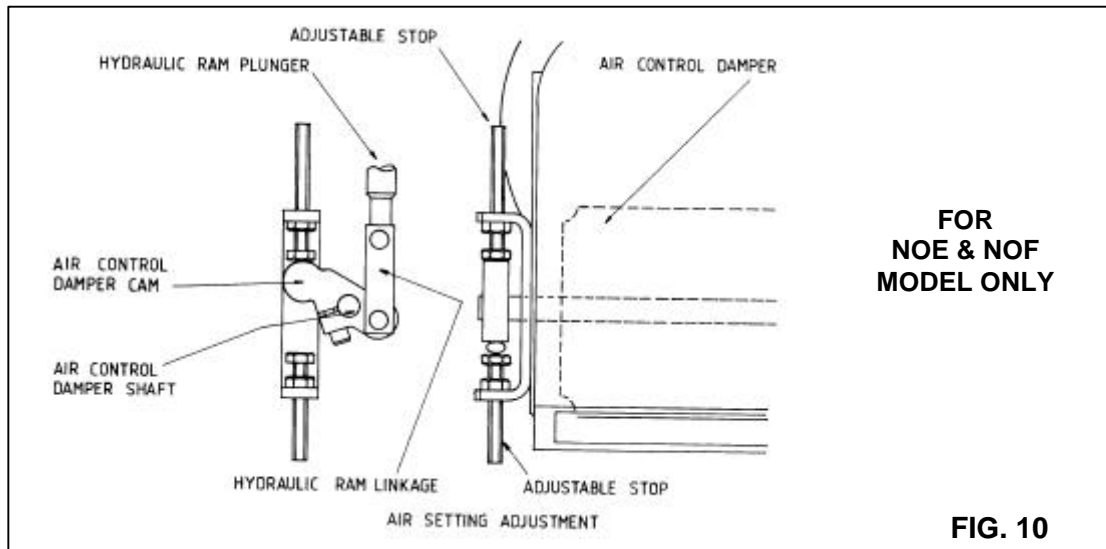

Air Diffuser

The air diffuser is fitted to the front end of the inner assembly of the burner and located within the flame tube attached to the hinged extension.

The function of the air diffuser is to control the volume of combustion air and create a pressure drop over the burner head to ensure a stable flame with good fuel/air mixing.

The position of the air diffuser is constant, (Fig 11)

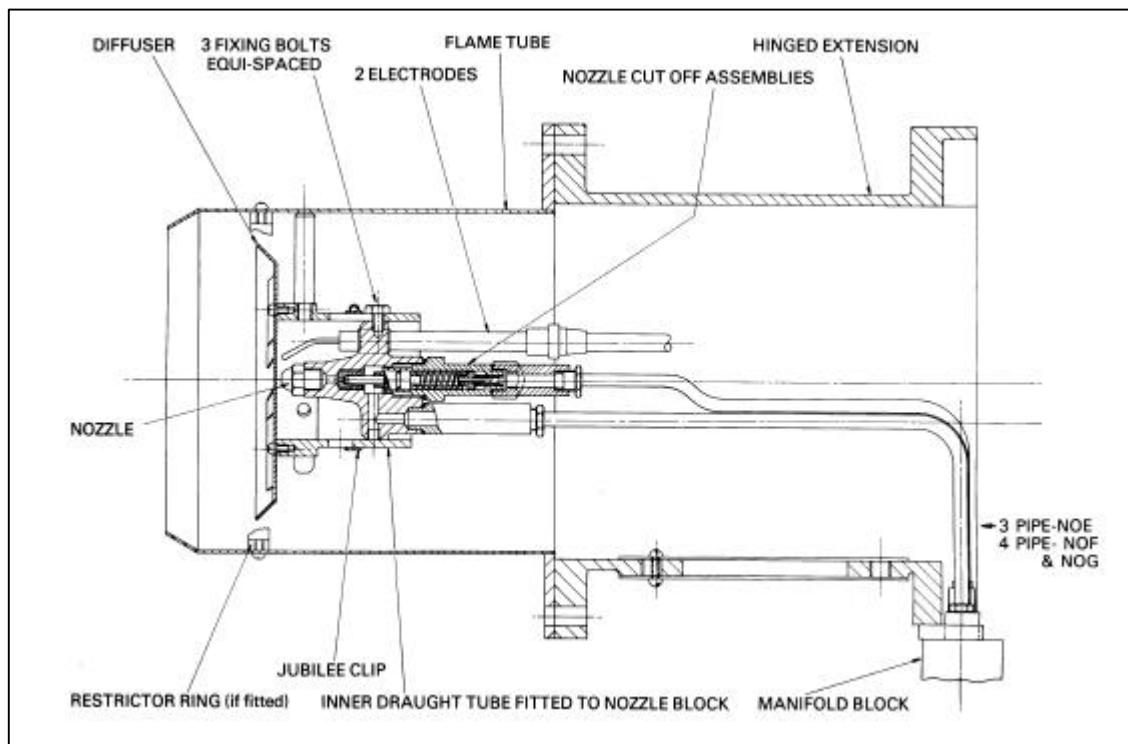

FIG. 11

HEAD ARRANGEMENT FOR NOE/F/G H/L BURNERS

Primary Air Tube - Fig. 11

Forms part of the burner inner assembly. Its function is to regulate the volume of primary combustion air passing through the centre of the air diffuser and over the oil nozzles. The regulating holes may be fully exposed or partially restricted depending on the burner firing rate and characteristics of the appliance to which it is fitted. However, under no circumstances should the primary air holes be restricted by more than 75%.

Restrictor Ring - Fig. 11

Located in the flame tube and fixed in position at the factory. Restrictor rings are included in the burners only when required. Restrictor rings when fitted are used to create a high air pressure drop across the burner head to ensure good fuel/air mixing.

MODEL NOG BURNER WITH ELECTRIC SERVOMOTOR OPERATED AIR DAMPER

Adjustment of Berger LAHR (Air Regulator) Motor Cams

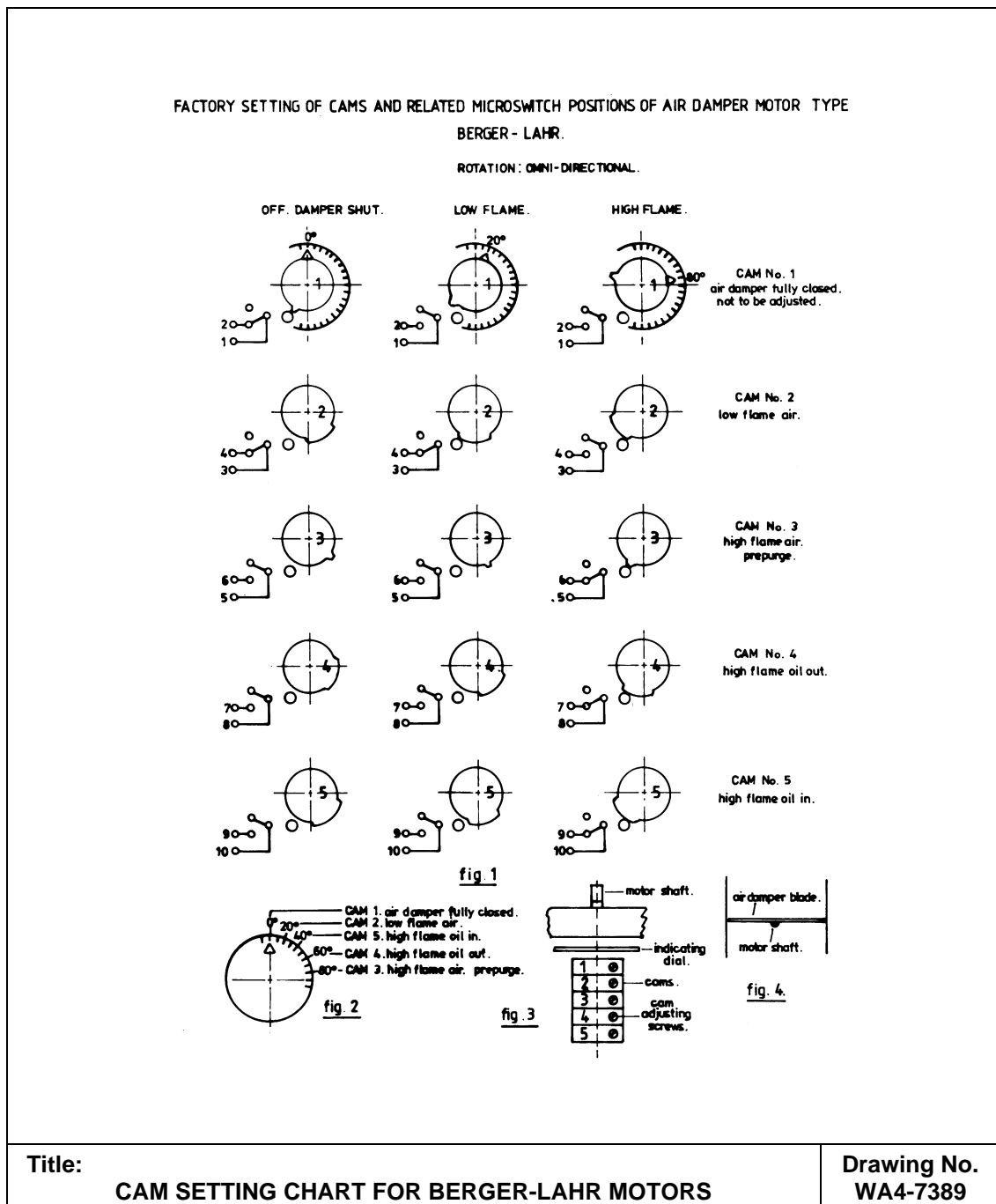

Cams are 'factory set' as per WA4-7389. Cams Nos.2 to 5 will require adjusting when burner is installed on its appliance, to cater for the particular nozzle size, resistance, etc. Re-check Cam No.1 for fully closing.

The sequence provides for a 'closed' air damper position when the burner is in the 'off' position. This prevents cold air being drawn through the boiler and taking heat away wastefully up the chimney. (Alternative to this is to have a 'fully closing' damper fitted in exhaust system).

Sequence of Operation

On demand for heat, the motor will drive the air damper to high flame air setting for pre-purge of appliance by burner fan, and then returning air damper to low flame position for light-up. (Motor drives clockwise to high flame).

When burner has ignited and there is a demand for high flame, motor will drive and start to open up air damper and also via its cam/micro switch (No.5) energise the three-way magnetic valve (which in turn hydraulically controls high flame air position (adjustable). Cam No.3 will stop motor at high flame air position. When high flame heat demand is satisfied (provided high/low sequence is being used), motor will drive air damper to low flame position, de-energising three-way magnetic valve (position again adjustable via Cam No.4) which in turn closes the high flame nozzle. When heat demand is fully met motor will drive air regulator to the closed position.

To Adjust

No attempt should be made to adjust Cam No.1, which controls the closed position, unless abnormal operating conditions warrant it, i.e. large amount of refractory in combustion chamber/top firing, etc, giving excess amount of 'back radiation' onto burner on shutdown (see note on wiring diagram).

- 1) To increase low flame air, hold burner in low position with switch in panel, Cam No.2 should be adjusted by turning adjusting screw with small screwdriver anti-clockwise slightly. Damper will not move until motor has driven some distance towards high flame position, this can easily be done by moving switch in panel to 'high' position and returning to low position, when damper will take up new setting.
- 2) To decrease low flame, again hold in 'low' position and turn adjusting screw in a clockwise direction, very slightly. Damper will close immediately.

It is very important to note the indicating pointer position before and after any adjustment, in order to make sure air damper has been adjusted the correct way.

- 3) High flame air. Factory setting is in the fully open position, therefore to decrease air turn Cam No. 3 anti-clockwise (panel switch in high position), move switch to low and return immediately to high, when air damper will re-position. To increase high flame air turn adjusting screw clockwise and damper will react. Never try to take high flame air setting more than the 90° fully open position.
- 4) Cam No.4 facilitates 'phasing of air/fuel and provides a 'high' flame oil 'in'. By adjusting this cam clockwise the three-way magnetic valve which indirectly controls high flame nozzle can be delayed or vice-versa by adjusting anti-clockwise.
- 5) Cam No.5 phases high flame oil 'out' and adjustment is similar to Cam No.4.

Finally, re-check on all positions after adjustment (CO₂ readings, etc).

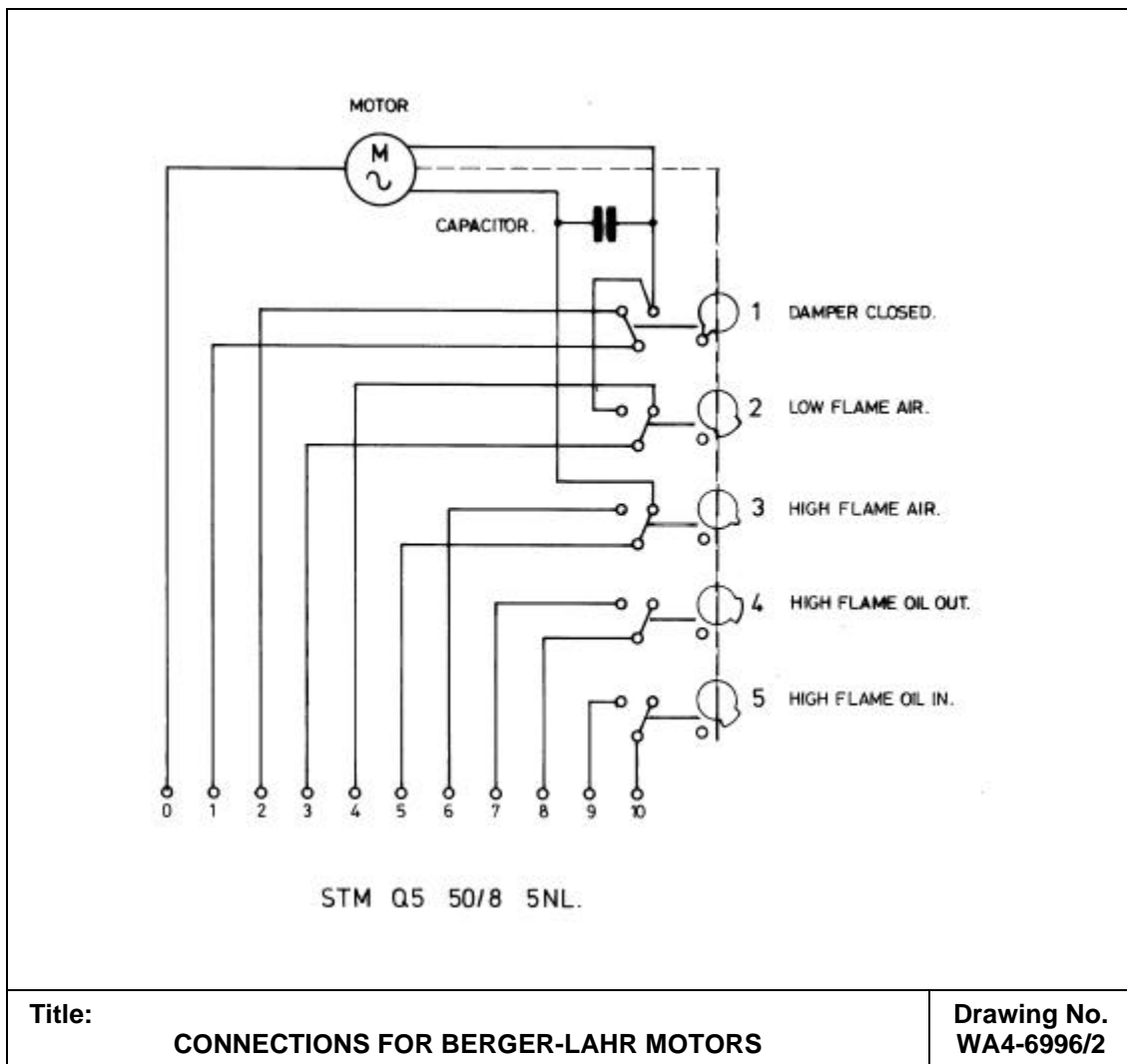

Instructions for 'Factory Setting' of Berger Motor or Fitting of Replacement Motor

Before motor is fitted to burner, cams to be set approximately as shown on WA4-7389.

To Set

Remove motor cover – rotate motor shaft (with special lever fitted) until flat is at top. Motor held as mounted on burner (conduit entry at top) this will be its closed position, indicating pointer will also be at T.D.C. All cams now to be adjusted and set, rotating lever on shaft cams can be easily moved to facilitate settings.

Berger LAHR Motor and Air Damper Position Indicators

The Berger LAHR Motor is fitted with an indicator, Illustration A; this is to facilitate the easy and correct setting of the various Cams Nos. 1 to 5. See also WA4-7389, this shows the setting and relationship of the five cams.

The Air Damper Spindle is also fitted with a pointer, and an indicator as illustrated in Illustration B. this indicator is located at the rear of the Burner Air Inlet.

IMPORTANT

DO NOT adjust cams whilst the Motor is rotating.

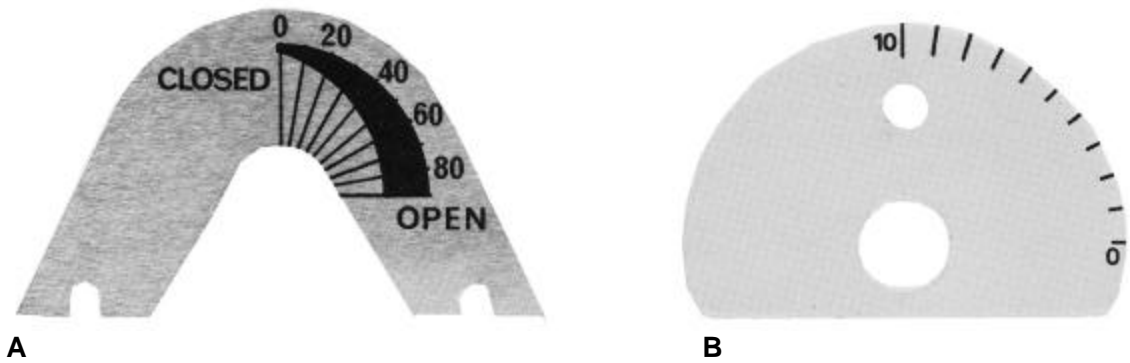

BURNER OIL COMPONENTS

Inner Assembly – Fig.11

The inner oil assembly is located in the hinged extension/flame tube of the burner. Its primary function is to carry preheated oil from the manifold block to the atomising nozzles.

Nozzle Block – Fig. 11

The multiple nozzle block is isolated at the forward end of the inner assembly. It houses the oil burner nozzles, the spring-loaded and spring-loaded/hydraulic piston cut-off assemblies.

On/Off Low Fire Spring-Loaded Piston Cut-off Valve – Fig 11/12

Its function is to provide an immediate and positive cut-off of the oil supply through the nozzle. It opens when the atomising oil pressure reaches 13.8 bar (200 psi-14 kg/cm²) and exceeds the spring pressure behind the piston. It closed immediately the burner motor is de-energised and the pump pressure begins to fall.

High Fire Hydraulic Spring-Loaded Piston Cut-off Valve – Fig 11/12

The valve is operated by the three-way magnetic oil valve. When the burner is on low fire the oil pressure is maintained behind the piston which, together with the spring resistance, keeps the nozzle cut-off valve closed. On change to high fire the three-way magnetic valve allows oil to be discharged from behind the piston so that the oil pressure on the nozzle side of it exceeds the spring resistance and allows the cut-off valve to open and the nozzle to spray oil.

FIG. 12

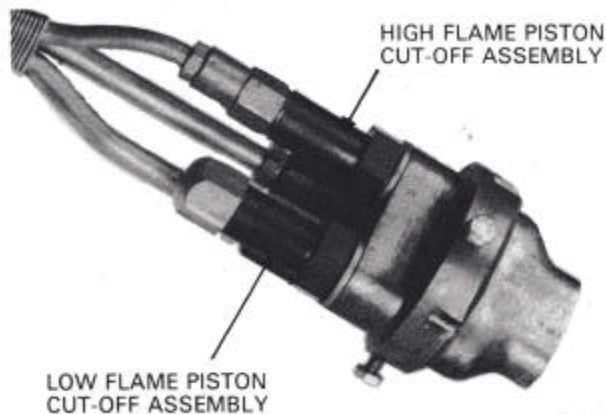

Oil Nozzles

The oil nozzles are fitted into the forward end of the nozzle block. The function is to spray oil into the combustion chamber at atomising temperature and pressure and in a volume commensurate with the capacity of the appliance to which the burner is fitted.

IMPORTANT NOTE:

When fitting nozzles to the NOE/F/G burners the nozzle filters must be removed.

In calculating the correct size of nozzles to be fitted, the following should be taken into account:-

Nozzles are marked for capacity and calibrated at an oil pressure of 7 bar/100 psi. the correction factor to be used to establish the nozzle sizes is as follow:

Nozzle marking x 1.66 = Imperial Gallons at 27.6 bar – 400 psi

Nozzle marking x 7.16 = kg/h at 27.6 bar – 400 psi

Primary Air Tube – See Fig. 13

Air Diffuser – See Fig. 13

IGNITION ELECTRODES

These are located and fitted as an integral part of the inner assembly. The function is to provide a source of spark ignition to the atomised oil discharge from the nozzles.

OIL MANIFOLD BLOCK – Fig 3

The oil manifold block is located beneath the hinged extension. It includes a cartridge heater and controlling thermostat designed to keep residual oils in the inner assemblies at pumping viscosity during the burner off periods. The thermostat is factory set at 45°C and in unalterable.

The oil manifold block also includes a pressure relief valve fitted between the flow and return ports to relieve excessive build-up during the initial oil circulation period following a long burner shutdown in cold environmental conditions. The pressure relief valve is set to operate at 8 bar (116 psi – 8.1 kg/cm²).

Two pressure gauges are fitted to the oil manifold block to show atomising and hydraulic oil pressures.

Magnetic Valve and Manifold Unit

The magnetic oil valves are fitted to a manifold directly mounted onto the surface of the oil preheater tank. Its location is designed to make use of residual heat from the oil preheater tank so as to keep the body of the magnetic valves as warm as possible. A non-return valve is fitted in the manifold to prevent oil spillage from it during service work.

Magnetic Valve (Two-Way)

The function of the two-way magnetic valve is to control the oil at atomising pressure through the inner assembly to the burner nozzles via the nozzle cut-off valve assembly.

Magnetic Valve (Three-Way)

Its function is to control the supply of oil to the hydraulic/spring-loaded nozzle piston cut-off assembly and hydraulic ram mechanism operating the air control unit during the change to low fire. On the change from high to low fire the three-way magnetic valve exhausts oil to the return side of the oil pump system.

Ensure the ports of the three-way oil valve are kept clean and free of any obstruction. Failure to do so may cause malfunction of the burner sequence.

It is imperative that the quick-release flexible pipes are connected before the burner is switched on.

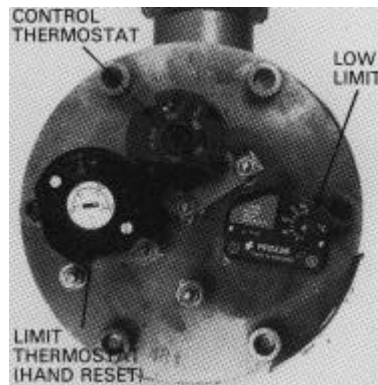

FIG.13

OIL PREHEATER TANK – Fig 13

The oil preheater tank is mounted on the burner ahead of the fan housing. Its function is to preheat the oil to the correct atomising temperature. The unit is equipped with three thermostats, 'low temperature', 'operating' and 'limit'. A thermometer and hot oil filter are mounted together as one unit on the top left-hand side of the preheater tank viewed from the rear of the burner.

OIL PUMP – Fig. 5

The oil pump is mounted on the right-hand side of the burner viewed from the rear. It is directly driven from the burner motor and provides a sufficient volume of oil to the nozzles via the preheater tank at the correct pressure for atomisation.

MICRO SWITCH

Located on the burner body. Its function is to interrupt the burner sequence controller and prevent a re-start when the burner hinged extension is open.

OIL CIRCULATION THERMOSTAT – Fig. 5

This unit is included as standard equipment on all NOF/NOG residual oil burners.

The intermittent circulation thermostat is fitted in the return line from the pump to the oil supply line.

Its function is to energise the burner oil pump via the motor so that hot oil at low pressure will be available at the nozzles at all times and particularly in those cases where cold environmental conditions are experienced.

As a circulation thermostat is fitted to the NOF/NOG burners it is vitally important that the burner is switched "off" at the on/off switch on the burner control panel. **"NEVER AT THE MAINS ISOLATOR"** except when the maintenance and servicing is being carried out.

Set thermostat at 80°C on NOF burners and 115°C on NOG burners.

CONTROL PANEL

Is mounted on the left-hand side of the burner viewed from the rear. It includes the Sequence Controller, Ignition Transformer, Motor and Preheater Contactors, Low Flame/Auto Hand Switch, On/Off Switch, Lights and Terminal connections.

A separate auxiliary panel for steam boilers (AOTC) requirements can be supplied on request.

5. PRE-FIRING CHECK AND INITIAL SETTINGS

1. Check that the burner is built to the correct specification for the appliance.
2. Check that the burner nozzles are fitted and are of the correct size for the appliance rating.
3. Check that the power supply to the burner is correct and all ancillary control circuits are connected.
4. Check that the oil supply is adequate and installed according to local Codes of Practice.
5. Check that the appliance to which the burner is fitted is in a proper state to be fired. (For instance: Is there water in the boiler?)
6. Check that the oil and electric supplies to the burner are turned off.

PRE-COMMISSIONING

Remove the cover from the hydraulic ram mechanism situated at the rear of the air inlet. Adjust the low flame travel stop so that the air control is approximately 15% open. Adjust the high flame travel stop so that the air control is approximately 50% open. Tighten all locking nuts after the adjustments have been made.

Note:

1. These initial recommendations are for general guidance at this stage. Final adjustments may be necessary later to suit the appliance requirements and possible variable site conditions.
2. At this stage it is important to establish that the preheater is full of oil. It is vitally important since the oil preheater tank may have been drained of oil at the factory after testing so as to comply with shipping conditions under the heading "Hazardous Cargo". This operation can be carried out by removing the filter/thermometer block.
3. It will also be necessary to manually prime the pump for the reasons outlined in 2 above. Turn on oil supply to burner. Remove the bleed port plug and purge the pump of air.

COMMISSIONING

Turn on the oil supply to the burner.

Open the control panel and set the low flame hold switch in the low flame position. Close the control panel.

Check that all auxiliary controls are correctly set.

Turn on the power to the burner.

The oil preheater will become energised and take approximately 10-15 minutes before it reaches a temperature to satisfy the low oil temperature thermostat.

PREHEATER THERMOSTAT SETTINGS

FUEL	Low Limit		Control		High Limit	
	°C	°F	°C	°F	°C	°F
Class E - 8 cSt at 100°C	50	122	85	185	95	203
Class F - 20 cSt at 100°C	71	160	110	230	127	260
Class G - 40 cSt at 100°C	94	200	143	290	149	300

PRE-PURGE OF BURNER FUEL SYSTEM – Fig. 8/9

The burner fuel system is designed to prevent cold oil in the burner pipework passing through the nozzles during the starting cycle. On receiving a signal from the low temperature thermostat of the oil preheater, via the sequence controller (Fig. 17) the burner motor which drives the combustion air fan and fuel pump will start. For a predetermined period oil from the pump will pass through the oil preheater, the inner assembly, nozzle block and the on/off magnetic oil valve and return to the suction side of the pump. During this predetermined purge period no oil will be discharged through the burner nozzles since the spring-loaded/hydraulic and spring-loaded nozzle cut-off valves will remain closed. During this predetermined purge period no oil will be discharged through the burner nozzles since the spring-loaded/hydraulic and spring-loaded nozzle cut-off valves will remain closed.

FIG. 14

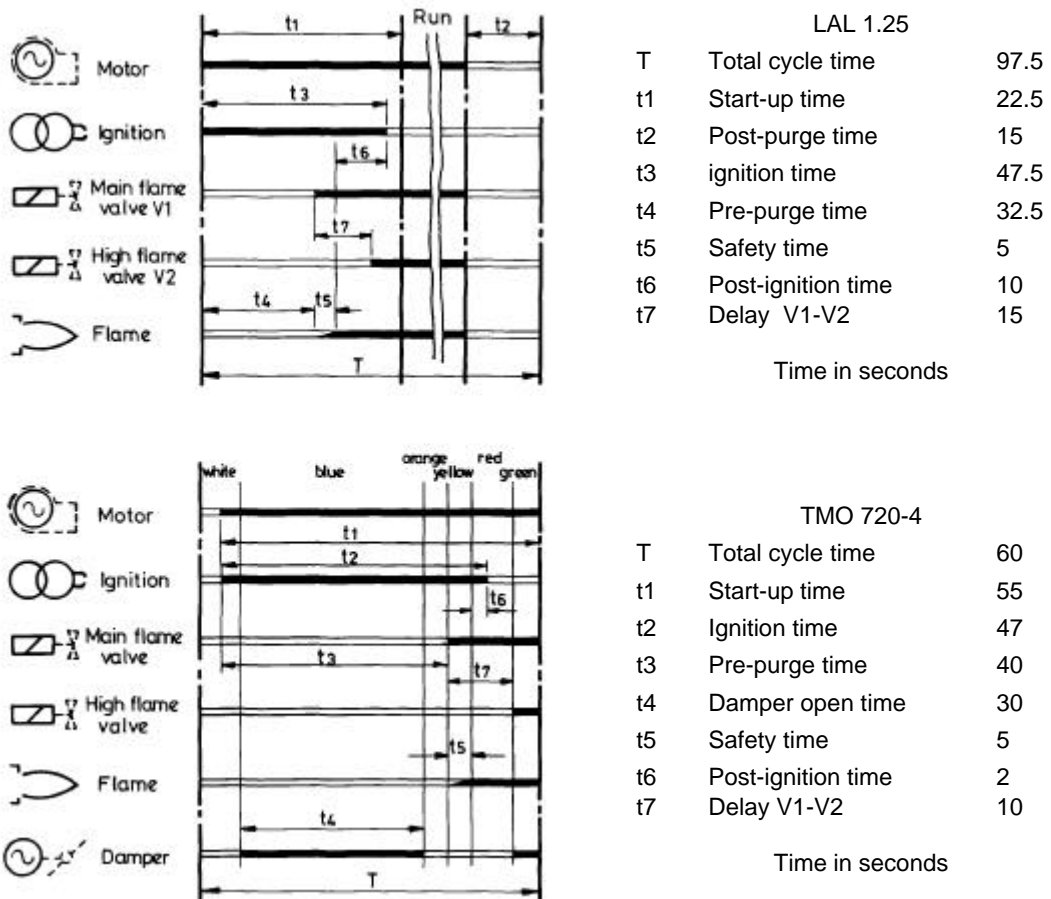

Little or no oil pressure will be recorded on the pressure gauges.

At the same time the ignition spark will occur across the electrodes.

STARTING - LOW FIRE (ONE STAGE)

At the end of the predetermined purge period the on/off magnetic oil valve will be energised and close thus preventing the return of oil to the suction side of the pump. Simultaneously the hydraulic lines to the ram operating the air control and the high fire nozzle cut-off assembly will be pressurised. The oil pressure will immediately rise and both the atomising pressure gauge and the hydraulic circuit pressure gauge will show 27.6 bar (400 psi – 28.12 kg/cm²). The low flame spring-loaded nozzle cut-off valve will open as the pressure rises through 13.8 bar (200 psi - 14 kg/cm²) and allow oil to be sprayed through the low fire nozzle. (Fig. 9).

The burner will now operate on low flame.

At this stage it may be necessary to make adjustments to the air control low flame setting to give a clear but not sparky flame when viewed through the burner inspection window.

Allow the burner to operate under these conditions until the appliance and flue system are at normal operating conditions.

Check the oil temperature on the gauge. See table in Section 3.

Check that the atomising oil pressure is in accordance with the figures given above. Inspect the flame through the inspection window provided. It should be clear with a steady bright light visible through the slots in the air diffuser and a continuous halo is visible around the outer edge of it.

With the burner now working on low fire, a check may now be carried out with suitable instruments to establish combustion efficiency.

It may be necessary to make some further adjustments to the flow flame air control settings.

Flue gas analysis of approximately 10-11% CO₂ with a smoke number of 3-4 should be achieved at this stage of commissioning and dependent upon site conditions.

After each adjustment of the air control further combustion efficiency checks should be made.

Switch off the burner. The flame should be extinguished immediately and the oil pressure shown on both the atomising and hydraulic pressure gauges should quickly fall to zero or slight above zero.

High Flame Operation

Open the control panel, set the Low Flame hold switch to the High Flame/Auto position. Close the control panel.

Switch on the burner.

The burner will again follow the sequence described above in the Low Flame section. After a predetermined time, see logic diagram, the sequence controller will signal the three-way magnetic valve. The valve will now close internal ports preventing oil at pressure reaching the high flame nozzle cut-off valve and hydraulic circuit operating the air control. A further port in the three-way valve will open simultaneously and discharge the fuel behind the high flame nozzle cut-off valve and air control circuits to the suction side of the pump. This operation allows the high flame nozzle cut-off valve to open and the hydraulically operated air control to move to the high flame air setting. The pressure shown on the hydraulic system gauge will fall to zero. The atomising pressure will remain at 27.6 bar (400 psi – 28.12 kg/cm²). The burner is now in the high flame operating position. (See Fig. 8)

Check the oil temperatures. (See table in Section 3).

Check that the atomising oil pressure is in accordance with the figures given above. Inspect the flame through the inspection window provided. It should be clear with a steady bright light visible through the slots in the air diffuser and a continuous halo is visible around the outer edge of it.

With the burner now working on high fire, a check may be carried out to establish combustion efficiency.

It may be necessary to make some adjustments to the high flame air control settings.

Flue gas analysis of approximately 12-13% CO₂ with a smoke number of 3-4 should be achieved at this stage of commissioning and dependent on site conditions.

After each adjustment further combustion efficiency checks should be made.

With the burner on high fire, open the control panel and set the low flame switch to low flame hold. This operation should be repeated a number of times to establish that smooth changeover from high to low and low to high fire is evident.

Air in the system may result in a sluggish operation. Bleed the air from the burner and re-check.

When taking combustion efficiency tests care should be taken to eliminate any ingress of air around the sampling point. If such air is present false readings will be recorded.

In commissioning, Nu-way NOE/F/G burners supplied as part of a packaged unit, the appliance manufacturer's instructions and figures relative to combustion efficiency, smoke density and exit flue gas temperatures should be followed.

CHECKING THE SEQUENCE CONTROLLER

Remove the photo electric cell from its holder while the burner is running and cover it with a clean cloth to exclude any light. The burner will stop within two seconds. The control circuit will recycle and the burner will go through a normal light-up procedure. A flame will be established, but since the photo electric cell can see no light the burner will go to lockout.

The safety flame failure sequence is thus proved.

Replace the photo electric cell. Re-set the sequence controller and allow the burner to establish the normal operating Sequence.

Check that the appliance auxiliary controls are correctly set and within safe limits.

Burner commissioning is now complete.

The burner will now operate until switched off by:-

- a. the controlling instruments of the appliance
- b. manually
- c. power failure. Upon restoration of the power after failure the burner will re-start automatically and follow its sequence through post purge to a stop situation followed by a normal re-start.

6. ROUTINE MAINTENANCE

When carrying out routine maintenance always turn off the power supply to the burner.

Regularly clean the fan blades with a stiff brush. Access is through the top cover secured by 4 screws.

Frequently inspect the air inlet to the burner and ensure there are no obstructions to air flow and that it is dust free.

To clean the following components the inner assembly must be removed:-

IGNITION ELECTRODES

Clean and check for cracks in the porcelain. If cracks are found the electrodes must be renewed.

Check the setting of the electrodes and re-set if necessary to dimensions shown.

Fig. ?

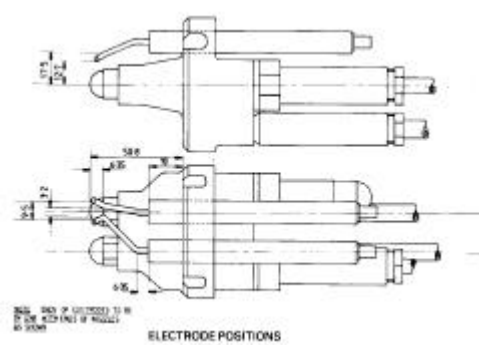

AIR DIFFUSER

Clean with a stiff brush. Remove any soot particles or light carbon which may have accumulated.

NOZZLES

If nozzles have to be cleaned care should be taken not to scratch or damage the finely finished surfaces.

IMPORTANT NOTE:

Nozzle life is approximately 2000 hours of operation. Unless replaced there will be a noticeable deterioration in atomisation and plant efficiency.

To remove inner assembly proceed as follows:-

The oil system of the burner must be allowed to cool down before attempting to remove the inner assembly.

Disconnect the self-sealing quick-release couplings at the inner assembly manifold block and magnetic oil manifold block. Open the hinged extension by removing the securing nuts. Disconnect the ignition leads from the electrodes. Remove the two Allen screws from the manifold union block.

The inner assembly complete may now be removed. Special attention should be given to the security of the three 'O' rings which form the seal between the inner assembly and the oil manifold block.

Reverse the above procedure when replacing the inner assembly ensuring the three 'O' rings sealing the triple union block to the oil manifold block are in position.

Failure to replace the 'O' rings will result in serious oil leakage.

Reconnect the ignition leads to the electrodes.

Close and secure the hinged extension.

Reconnect self-sealing quick-release couplings.

PHOTOCELL

Clean the photo electric cell lens with a dry, clean cloth.

COLD OIL FILTER

Rotate the cleaning knob daily.

The plug in the sump should be removed approximately every month/four weeks to drain off any sludge or water that may have accumulated there.

HOT OIL FILTER – Located in Oil Preheater

Remove and clean filter at regular intervals (i.e. weekly).

A fall off in atomising pressure is an indication that the filter needs cleaning.

Replace all covers and secure all fittings before switching on the burner.

During routine plant room cleaning and maintenance it is advisable to cover the burner so as to prevent fouling and damage to occur.

7. FAULT FINDING**BURNER MOTOR FAILS TO START**

Check power supply to the burner and that burner is correctly wired.

Check fuses and motor overload in burner control panel.

Check that hinged extension microswitch is closed.

Check that control box is not locked out – reset.

Check that control box is operating correctly by checking for a feed from the control box to terminal 95 on the contactor. If found to be faulty – replace.

Check that control instruments are “calling for heat”.

Check that oil preheater limit thermostat has not tripped.

FAN STARTS – NO FLAME. BURNER GOES TO LOCKOUT

SYMPTOM	POSSIBLE REASON	REMEDY
No ignition	Check electrode setting. Cracked electrode porcelains. Ignition leads disconnected. Fault transformer.	Reset. Renew. Reconnect. Replace.
No Flame	Interrupted oil supply. Low oil pressure. Magnetic oil valve fails to close. Faulty oil pump. Fire valve closed. Choked nozzles. Restrictor ring not fitted in Main Valve Bleed	Rectify. Check pump filters Check coil Replace Reset Clean or replace Replace. See Fig 6B.

BURNER STARTS, FAILS TO RUN

SYMPTOM	POSSIBLE REASON	REMEDY
Burner starts, Fails to run.	Partially choked nozzle. Soot/carbon on diffuser. Low oil temperature. Too much air. Dirty photocell lens Wrongly positioned photocell. Oil shortage. Faulty wiring.	Clean or replace Clean Check thermostat settings Adjust air control Clean Adjust Check supply Crossed polarity

IMPORTANT:

Check that the Sequence Controller and Photo Electric Cell are compatible.

BURNER STARTS, FAILS TO CHANGE TO HIGH FLAME

Three-way oil valve fails to change over. Check wiring and valve coils.

Check storage tank to ensure that there is sufficient oil and at the required temperature.

Check and ensure that the high/low switch is set to high flame position.

8. SPARE PARTS IDENTIFICATION

Separate illustrated lists, containing an item number, description and code number are available. The variations on a component are included and care must be taken when making any reference to a component to use the correct description and code number.

MODELS

NOE
NOF
NOG

FUEL

The three models of heavy oil burners are suitable for use on residual fuels with viscosities as specified below.

Model NOE

Class E: 8 cSt at 100°C

Model NOF

Class F: 20 cSt at 100°C

Model NOG

Class G: 40 cSt at 100°C

NOTE:

All burners incorporate a factory set oil pre-heater unit.

Minimum oil temperature at burner inlet:

16°C for Class E Oil

43°C for Class F Oil

83°C for Class G

FUEL SYSTEM

All burners must have a heated ring main oil supply system.

Two atomising nozzles are used

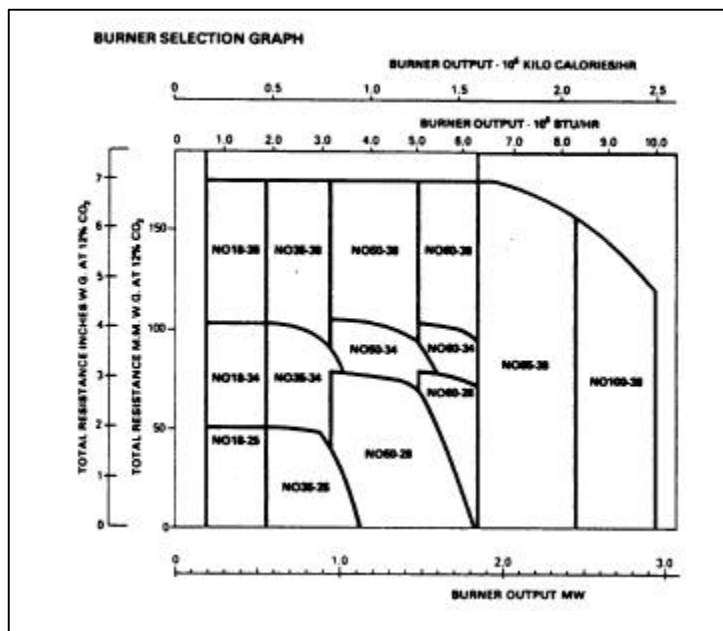

Ring main system

Residual fuel Class E, F & G

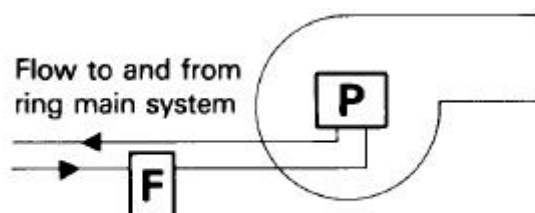

Typical burner designation: **NOE 35-34 T3L 240**

FULL BURNER DESIGNATION

BURNER TYPE	NO	E,F,G	35	34	T	3	L/S	240/430
OIL TYPE								
NOMINAL OUTPUT (in 1000,000 Btu/h)								
FAN DIAMETER (cm)								
OPERATION								
ELECT. SUPPLY								
CONTROL MAKE								
PROJECTION								

Nu-way's policy is one of continuous improvement. The right to change prices and specifications without notice is reserved.



BS EN ISO 9001
CERT No. FM00921
Issue August 2002

Enertech Limited,
P O Box 1,
Vines Lane
Droitwich,
Worcestershire,
WR9 8NA

Tel: +44 (0) 1905 794331
Email: info@nu-way.co.uk

Fax: +44 (0) 1905 794017
Web: www.nu-way.co.uk

