

Installation & Maintenance Manual

**MGN 1550 – 2000 LN T3D
(MPA22)**

Gas Burner

Contents

1	General information	3
2	Checking scope of delivery and connection data	3
3	Maintenance and customer service	3
4	Operating instructions	3
5	Instruction of operating personnel	3
6	Filter/Strainer	3
7	Key for code designation	4
8	Technical specifications	4
9	Boiler connection dimensions	4
10	Installing the gas jacket on the boiler.....	5
11	Mounting the burner housing on the gas jacket (service position)	5
12	Electrical connections	5
13	Air flap positioning motor	7
14	Air pressure monitor	7
15	Gas pressure monitor	7
16	Gas pressure switch for VPS	7
17	Adjustment of the ignition electrodes.....	8
18	Flame control with KLC1000.....	8
19	Control unit MPA 22	9
20	MPA 22 control and display.....	9
21	Start-up.....	9
22	Gas train KEV _{II} 1 ½" , KEV 2" and KEV DN65	10
23	Gas train KEV DN65, DN 80, DN 100	11
24	Adjustment mode -pneumatic gas-fired operation	12
25	Calculation principles for gas burner adjustment.....	14
26	Adjustment tables	15
27	Troubleshooting.....	16
28	Adjustments log	20
29	Overall dimensions	22
30	Working ranges.....	22

1. General information

Installation of a gas-fired heating system must be performed in accordance with the applicable regulations and guidelines. It is, therefore, the duty of the installation engineer to ensure that all regulations have been read carefully and understood. Installation, start-up and maintenance must be performed with utmost care.

The burner must not be operated in rooms with high levels of air humidity (laundry rooms), dust or corrosive vapours. The boiler room must be ventilated accordingly with ventilation air.

Nu-Way MG1190-2000-LN T3D Series gas burners are suitable for combustion of natural gas or liquid gas in accordance with EN 437 and are in compliance with the EN 676 European standard.

2. Checking scope of delivery and electrical data

Before installing the Nu-Way gas burner, please check that all items included in the scope of delivery are present.

Scope of delivery:

burner housing, gas jacket with burner pipe, mounting kit, documentation and gas train.

Gas installation and commissioning are subject to the applicable national regulations. The gas pipe must be designed to conform to the flow rate and the available gas flow pressure and routed with the lowest pressure loss over the shortest distance to the burner.

The loss of gas pressure via the gas train and the burner and the resistance on the fuel gas side of the heat generator must be less than the connection flow pressure.



Caution !

Observe sequence and throughflow direction of valves and fittings.

3. Maintenance and customer service

The complete system should be checked once a year for correct functioning and leaks by a representative of the manufacturer or other suitably qualified person.

We accept no liability for consequential damage in cases of incorrect installation or repair, the fitting of non-genuine parts or where the equipment has been used for purposes for which it was not intended.

4. Operating instructions

The operating instructions together with this technical information leaflet must be displayed in a clearly visible position in the boiler room. The address of the nearest customer service centre must be displayed on the back of the operating instructions.

5. Instruction of operating personnel

Faults are often caused by operator error. The operating personnel must be properly instructed in how the burner works. In the event of recurring faults, Customer Service should be notified.

6. Filter/Strainer

According EN676 a filter/strainer shall be fitted at the inlet of the safety shut-off valve to prevent the ingress of foreign elements.

7. Key for code designation

MGN 1190-LN

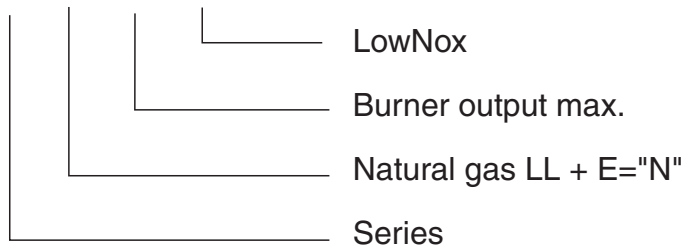

8. Technical specifications

Technical data	Burner type		
	MG1190-LN T3D	MG1550-LN T3D	MG2000-LN T3D
Min. burner output in kW	420	450	700
Max. burner output in kW	1193	1550	2000
Gas type	for natural gas LL+E = „N“		
Method of operation	2-stage sliding / modulating		
Voltage	3 / PE ~ 50 Hz 400 V / T 20 A		
Max. current consumption	20 A		
Electric motor power (at 2800rpm) in kW	3.0	4.0	4.5
Flame failure controller	KLC1000		
Control box	MPA 22		
Weight in kg approx.	110	115	120

9. Boiler connection dimensions

All dimensions in mm

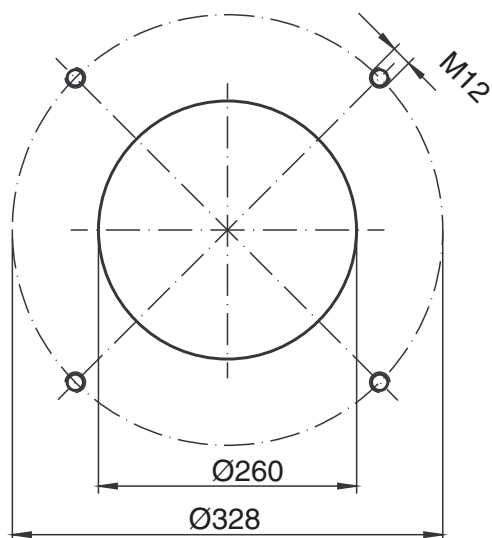

10. Installing the gas jacket on the boiler

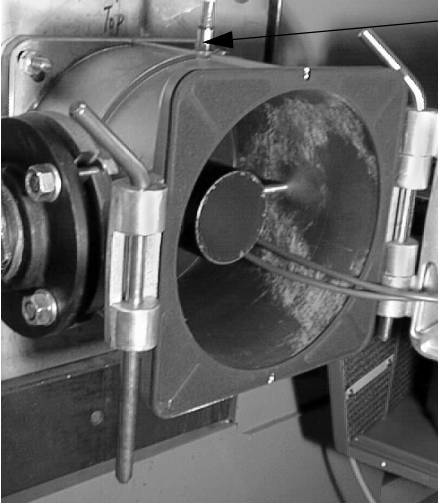

Air-pressure connector

The boiler connection plate has to be prepared in accordance with the sizes as stated in Section 8. "Boiler connection dimensions".

You can use the gas-jacket gasket as a template.

Using an 8 mm socket-head wrench, secure the gas jacket to the boiler with the 4 M 12 securing screws and washers.

KEV compact unit: screw in the air-pressure connector at the top.

Use adhesive to affix the gas-jacket gasket to the gas jacket.

11. Mounting the burner housing on the gas jacket (service position)

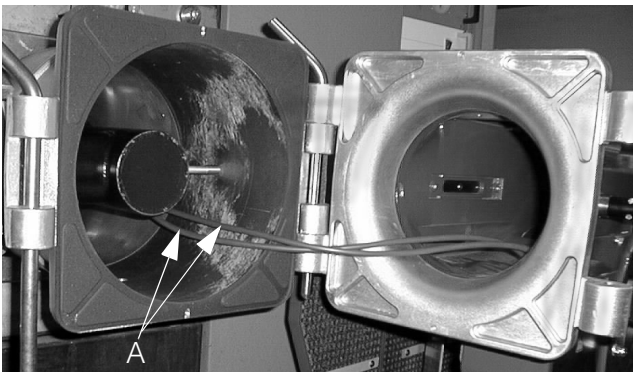

Position the burner housing in the gas-jacket hinge and secure it with a rod. The burner is now in the service position.

Connect ignition cable "A" to the ignition transformer.



Make sure that the gasket is correctly seated between gas jacket and burner housing.

Swing the burner closed and insert the second securing rod into the hinge. Tighten the screw at the top to secure the burner in position.

12. Electrical connection



Always set the main switch to "Off" and remove the fuse before connecting the cables or removing electrical components.

The burner must be connected to the electricity supply in accordance with the wiring diagram. This work must be performed by trained, qualified electricians. The supply cable to the burner must be of the flexible type.



See Circuit diagram

The cover has to be removed and set to the service position in order to permit access to the control unit. Remove the securing screws (1) and fold the cover down to the left.

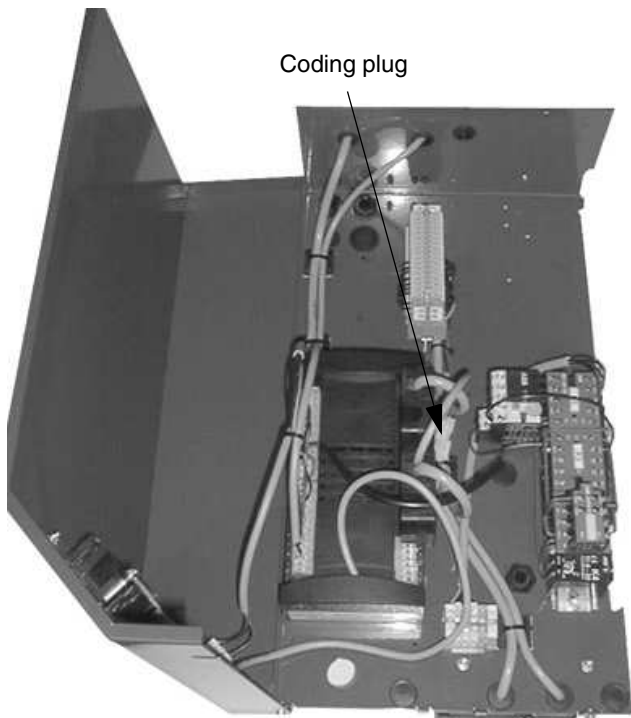

Two-stage or modulating operation



IMPORTANT !

The coding plug **X85** with jack **X86** must be connected during two-stage operation (as-delivered condition, see Fig.).

For modulating operation, the coding plug **X85** must be removed.

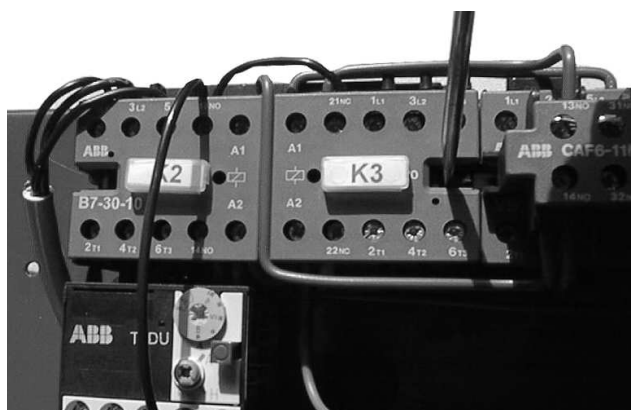

Once the connection to the electricity supply has been established, check the wiring and briefly actuate the motor contactor with an electrician's insulated screwdriver to check the direction of rotation of the burner motor.

The direction of rotation is correct if the fan turns toward the boiler (see the arrow on the motor flange).



IMPORTANT !

The motor protective relay is set ex-works. The set value should not be incorrectly adjusted.

13. Air flap positioning motor

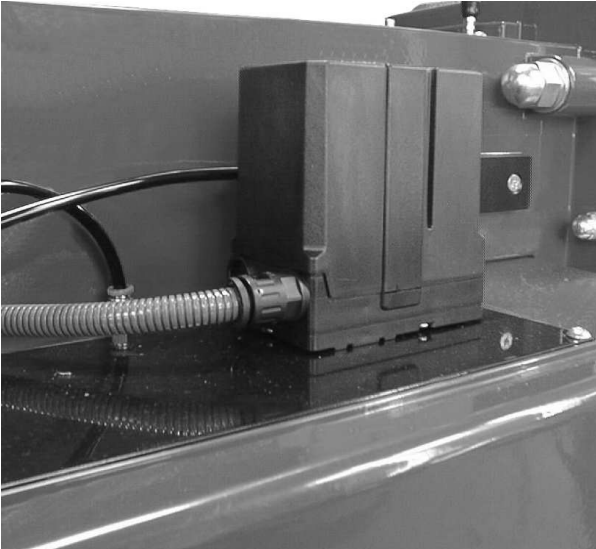

The air flap positioning motor is designed for air flap adjustment on progressive two-stage burners or modulating burners. The motor is activated electronically via the microprocessor-controlled control box.



Do not open the air flap positioning motor. The optics can become damaged irreparably. No warranty will be given if the seal is broken.

14. Air pressure monitor



The air pressure switch is a differential pressure switch and monitors pressure at the forced-air burner.

The air pressure switch is preset at the factory.

15. Gas pressure monitor

The gas pressure monitor serves to monitor the gas inlet pressure. The burner is shut down if the gas inlet pressure drops below the set minimum value (preset at factory to 12 mbar). The burner starts up automatically when the preset minimum pressure is exceeded.

16. Gas pressure switch for VPS

The gas pressure switch for VPS is preset to 10 mbar at the factory.



The operating point of the gas pressure switch for VPS must be set to half the inlet flow pressure.

17. Adjustment of the ignition electrodes

The ignition electrodes are preset at the factory.

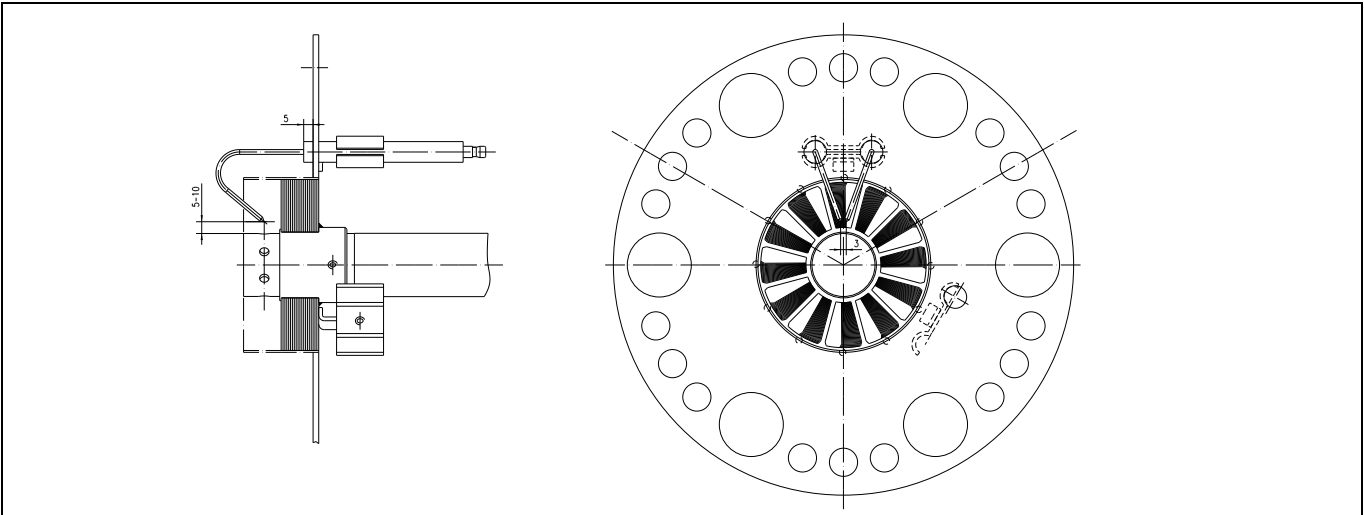

18 Flame control with KLC1000



Operating Indicator LED:

LED is OFF: KLC is not switched on – no power supply or 'no flame' is detected.

LED is FLASHING: KLC has detected a flame; the quality of the flame signal is indicated by the intensity of the flashing of the LED – fast flashing indicates a healthy flame signal and vice versa - slow flashing indicates a weak flame signal.

LED is ON: KLC has detected the strongest level of flame signal.

Commissioning and maintenance

The installation and commissioning must be done by qualified personnel only. Before energising the KLC flame detector please check the cable and wiring connections are in accordance to the diagram and instructions given above. For good maintenance which will ensure trouble free operation of the KLC flame detector; please keep the sight glass clean by wiping with a soft dry clean cloth. Warning: Do not use any kind of cleaning sprays or fluids. During commissioning and after any cleaning maintenance, the flame detector should be checked, as the UV tube is subject to a natural ageing process and towards the end of its life span it is prone to malfunction.

To check that the flame detector is sound we recommend the following procedures be followed:

- Start the burner with the fuel supply closed-off or remove the flame detector from its mounting flange and cover the UV tube using a soft cloth to avoid touching the glass lens. The control box will lock-out at the end of the safety time due to absence of a flame signal.
- Remove the flame detector from its mounting flange. Start the burner while exposing the flame detector to an external UV radiation source such as a cigarette lighter flame, or a small gas flame (n.b. electric room lighting or a torch is inadequate). The burner Control Box must go to lock-out due to detecting an extraneous light source either immediately or at the end of the air pre-purge cycle, depending on the type/model of the Control Box.
- Close off the fuel supply or remove flame detector from its mounting flange and cover the UV tube using a soft cloth when the burner is in the "run" position. The control box must go immediately to lock-out resulting in the burner shutting down.

If any of these safety checks do not function as described i.e. they should always result in burner shutdown and control box lock-out; then it is essential to replace the flame detector with a new KLC flame detector. For safety and trouble free burner operation, we recommend that the flame detector should be replaced after every 10,000 hours of burner operation or approximately every 30months for a burner operating on an average of 10 hours per day.

19. Control unit MPA 22

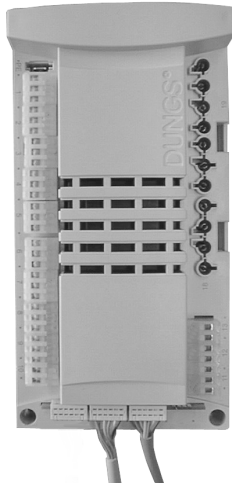

The MPA 22 is a microprocessor-controlled intermittent-duty control box for controlling and monitoring pneumatic modulating forced-air burners with an actuator drive. For operation as an automatic gas burner control with integral valve proving system. The MPA 22 has e-BUS connectivity.

20. MPA 22 control unit display

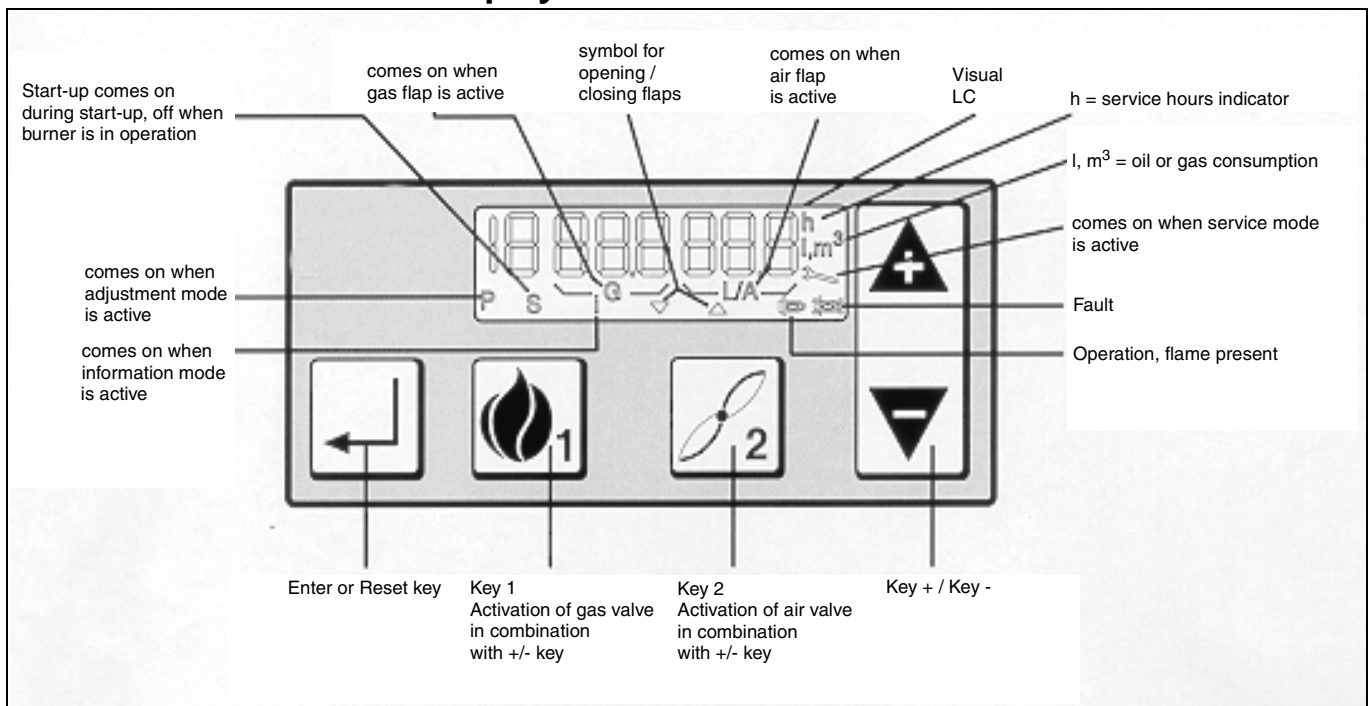

21. Start-up

The burner can be put into operation once the gas and electrical installation and assembly work has been completed.

- Check the connections on the gas train.
- Prepare the flue-gas analyser.
- Start the burner.
- Adjustment of air surplus and output. See 22. Gas train KEV_{II} 1 ½", KEV 2" and KEV DN65
- 23. Gas train KEV DN65, DN 80, DN 100
- Record the setting data.
- Check the gas pressure monitor after start-up. To do so, close ball valve slowly. The burner must shut down, but must not go into fault mode. If the burner goes into fault mode, increase the setting on the gas pressure monitor.

22. Gas train KEV_{II} 1 ½" , KEV 2" and KEV DN65

Installing the gas train	
Installation position	only in horizontal line, not tilted.
Minimum distance to walling	20 mm
Screw the combustion chamber pressure measuring nipple into the gas jacket at the top (see "10 Mounting the gas jacket on the boiler"). Route the connecting hose between the measuring nipple for combustion chamber pressure and the gas train in a loose loop.	

Screw each air pressure measuring nipple into the top of the gas jacket (see 10. Mounting the gas jacket on the boiler).

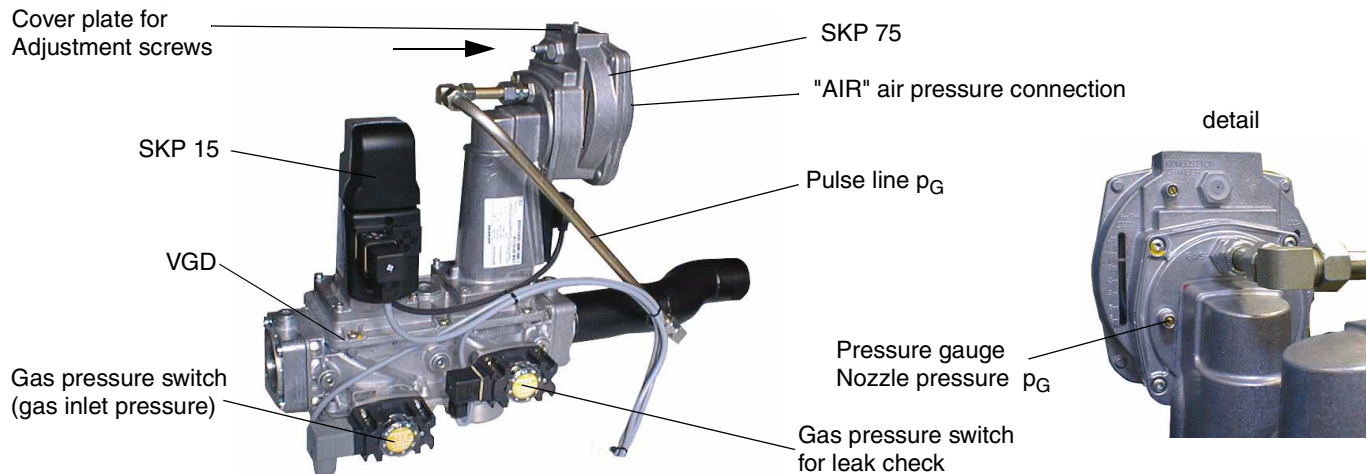

Connect the blue hose to the "AIR" connection on the gas train and the air pressure connection on the gas jacket. The blue hose serves as a control line for the gas train and must be routed in a loose loop without kinking.

Remove the plate for covering the adjustment screws from the gas pressure regulator.

Start the burner.

1. Setting the air surplus in high and low-load operation

- Set the air flap positions P9 for high-load operation and P1 for low-load operation as specified in 23. Adjustment tables. Follow the setting procedure described in 24. Adjustment mode - pneumatic gas-fired operation with MPA 22 display.
- In high-load operation, set the air surplus with the "large flame" adjustment screw on the gas pressure regulator. The CO₂ level in the flue gas should be 9-10% for natural gas.
- In low-load operation, set the air surplus with the "small flame" adjustment screw on the gas pressure regulator. The CO₂ level in the flue gas should be 9-10% for natural gas. The low-load setting influences the high-load setting.
- In high-load operation, check the air surplus and, if necessary, correct the setting with the "large flame" adjustment screw on the gas pressure regulator.

2. Setting the output in high and low-load operation

- Check the high-load setting via the gas flow at the gas meter or compare the nozzle pressure with the values stated in 26. Adjustment tables. The output can be increased by opening the air flap (to increase P9) and reduced by closing the air flap (to reduce P9). The air surplus is not affected by this adjustment.
- Check the low-load setting via the gas flow at the gas meter or compare the nozzle pressure with the values stated in 26. Adjustment tables. The output can be increased by opening the air flap (increase P1) and reduced by closing the air flap (reduce P1). The air surplus is not affected by this adjustment.

23. Gas train KEV DN65, DN 80, DN 100

Installing the gas train	
Installation position	only in horizontal line, not tilted.
Minimum distance to walling	20 mm
Screw the combustion chamber pressure measuring nipple into the gas jacket at the top (see "10 Mounting the gas jacket on the boiler"). Route the connecting hose between the measuring nipple for combustion chamber pressure and the gas train in a loose loop.	

Screw each air pressure measuring nipple into the top of the gas jacket (see 10. Mounting the gas jacket on the boiler).

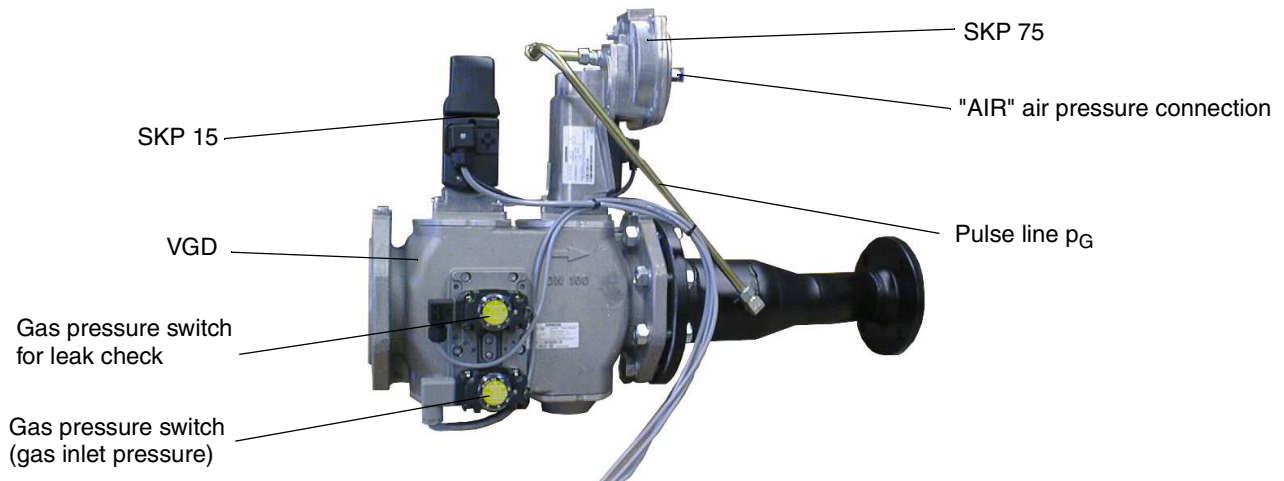

Connect the blue hose to the "AIR" connection on the gas train and the air pressure connection on the gas jacket. The blue hose serves as a control line for the gas train and must be routed in a loose loop without kinking.

Remove the plate for covering the adjustment screws from the gas pressure regulator.

Start the burner.

1. Setting the air surplus in high and low-load operation

- Set the air flap positions P9 for high-load operation and P1 for low-load operation as specified in 28. Adjustment tables. Follow the setting procedure described in 24. Adjustment mode - pneumatic gas-fired operation with MPA 22 display.
- In high-load operation, set the air surplus with the "large flame" adjustment screw on the gas pressure regulator. The CO₂ level in the flue gas should be 9-10% for natural gas.
- In low-load operation, set the air surplus with the "small flame" adjustment screw on the gas pressure regulator. The CO₂ level in the flue gas should be 9-10% for natural gas. The low-load setting influences the high-load setting.
- In high-load operation, check the air surplus and, if necessary, correct the setting with the "large flame" adjustment screw on the gas pressure regulator.

2. Setting the output in high and low-load operation

- Check the high-load setting via the gas flow at the gas meter or compare the nozzle pressure with the values stated in 26. Adjustment tables. The output can be increased by opening the air flap (to increase P9) and reduced by closing the air flap (to reduce P9). The air surplus is not affected by this adjustment.
- Check the low-load setting via the gas flow at the gas meter or compare the nozzle pressure with the values stated in 26. Adjustment tables. The output can be increased by opening the air flap (increase P1) and reduced by closing the air flap (reduce P1). The air surplus is not affected by this adjustment.

24. Adjustment mode - pneumatic gas-fired operation

OFF

To enter this adjustment mode, the burner must be on standby. Standby means that the burner is connected to the power supply, but no heating request has been issued. If **OFF** appears on the display on MPA 22, the unit is running in standby mode and has already been configured.

OFFUPr

If **OFFUPr** appears on the display, the MPA 22 is also running in standby mode, but the unit is still unprogrammed and all setting parameters still have to be entered by the following procedure.

Important: If the setting operation is interrupted within 30 min. or not completed correctly, **OFFUPr** will also be displayed.

To change new setting parameters or old setting parameters, follow these steps:



Step 1:

Enter the safety code. Press key 1 and key 2 simultaneously

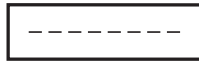

Step 2:

7 horizontal bars are now displayed. Enter the password as follows.

Note:

The intervals between the individual inputs must not be longer than 20 sec., as the MPA 22 will otherwise revert to standby mode. If this is the case, you will have to start the code entry procedure from the beginning again.

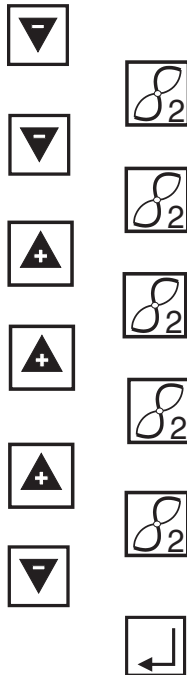

- Press the minus key twice.
 - Confirm your entry by pressing key 2 once.
 - Press the minus key once.
 - Confirm your entry by pressing key 2 twice.
 - Press the plus key 4 x.
 - Confirm your entry by pressing key 2 once.
 - Press the plus key twice.
 - Confirm your entry by pressing key 2 once.
 - Press the plus key 3 x.
 - Confirm your entry by pressing key 2 once.
 - Press the minus key 4x.
 - Press the enter key once.
- Password entry is now finished.

P GAS Pn

Step 3:

after the correct password has been entered, **EGAS Pn** appears on the display.

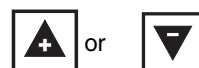

Step 4:

the operating points **P9 (max load)**, **P1 (min load)** and **P0 (starting point)** can now be selected by pressing the **plus or minus key**.

P 9GAS ~L/A~

Step 5:

After the operating point **P9** is selected, **9GAS** appears on the display. The max load operating point can be adjusted to values between 0° and 90 ° by holding down **key 2** and optionally pressing the **plus or minus key**.



For basic setting values, please refer to the adjustment table.



Step 6:

After you have set **P9**, press the **plus key** to set **P1**. **1Gas** appears on the display.

The min load operating point can be adjusted to values between 0° and 90 ° by holding down **key 2** and optionally pressing the **plus or minus key**.



For basic setting values, please refer to the adjustment table.

Step 7:



After you have set **P1**, press the **plus key** to set **P0** (the starting point). **0 Gas** appears on the display.

The operating point (starting point) can now be set to a value between 0° and 90° by holding down **key 2** and optionally pressing the **plus or minus key**. The value of **P1** should preferably be set. If **P1**, (min. load) is set to a very low value, it is recommended to set **P0** to a higher value than **P1** in order to ensure stable starting.



For basic setting values, please refer to the adjustment table.



Step 8:

After you have set **P0**, press the **plus key**.

GAS Pn. appears on the display.

Now close the safety chain and issue a heating request.

The burner should now start up and dwell in the ignition position. If this is not the case, please repeat the procedure for adjustment of ignition point **P0** under **step 7**.

After the burner has started up, the gas train must be set to the nozzle pressure specified in the adjustment table.



Step 9:

The setting values are now adjusted in relation to the boiler and the required burner output. The burner is in operation throughout the adjustment procedure so that all boilers and measured data relevant to the burner can be recorded.

Adjust the operating points in the order **P0,P1** and **P9** and make adjustments by simultaneously pressing **key 2** and the **plus or minus key**. To switch the burner to normal operation, press **key 1** and **key 2** simultaneously for approximately 2 sec. The burner switches to min output **P1** and then returns to normal operation.

The setting procedure is now completed.

Note:

If you want to change values after finishing the setting procedure, you will have to start from the beginning again.

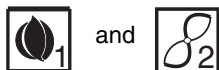
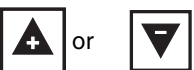
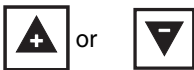

25. Calculation principles for gas burner adjustment

The values given in the tables are setting values for start-up.
The necessary system adjustment must be newly determined in each case.

General:

The calorific value ($H_{i,n}$) of fuel gasses is usually given for normal atmospheric conditions (0°C, 1013 mbar).

Natural gas type E $H_{i,n} = 10.4 \text{ kWh/m}^3$
 Natural gas type LL $H_{i,n} = 9.3 \text{ kWh/m}^3$
 Gas counters measure the volume of gas in the operational state.

Specifying throughput:

To allow correct setting of the heat generator load, the gas throughput must be determined in advance.

Example:

Height above sea level 230 m
 Atmospheric pressure B (according to table) 989 mbar
 Gas pressure P_G at counter 20 mbar
 Gas temperature ϑ_G 16°C
 Boiler rating Q_n 100 kW
 Efficiency η_K (assumed) 92%
 Calorific value $H_{i,n}$ 10.4 kWh/m³

Gas flow in standard state (V_n)

$$V_n = \frac{Q_n}{\eta_K \times H_{i,n}} = \frac{100 \text{ kW}}{0,92 \times 10,4 \frac{\text{kWh}}{\text{m}^3}} = 10,5 \frac{\text{m}^3}{\text{h}}$$

Gas flow in operating state (V_B)

$$V_B = \frac{V_n}{f} = \frac{10,5 \frac{\text{m}^3}{\text{h}}}{0,94} = 11,2 \frac{\text{m}^3}{\text{h}}$$

Conversion factor (f)

$$f = \frac{B + P_G}{1013} \times \frac{273}{273 + \vartheta_G}$$

Annual average air pressure

Mean geodesic height of supplied region ASL [m]	from to	0	1	51	101	151	201	251	301	351	401	451	501	551	601	651	701
Annual average of air pressure	(mbar)	1016	1013	1007	1001	995	989	983	977	971	965	959	953	947	942	936	930

Key:

Q_n = boiler rating [kW]
 η_K = efficiency [%]
 $H_{i,n}$ = lower standard calorific value [kWh/m³]
 f = conversion factor
 B = barometric pressure [mbar]
 P_G = gas pressure at gas counter [mbar]
 ϑ_G = gas temperature at gas counter [°C]

26. Adjustment tables



The values given in the tables are only setting values for start-up. The system settings required in each case must be redefined if values such as boiler output, calorific value and altitude deviate. **A correction is required in any case.**

MG1190-LN T3D Burner output Stage 2 Stage 1		Boiler output where $\eta_k = 90\%$ Stage 2	Natural gas LL $H_{i,n} = 9,3$ [kWh/m ³]				Natural gas E $H_{i,n} = 10,4$ [kWh/m ³]				Air flap Cam setting	
			Nozzle pressure Stage 2 Stage 1		Gas flow rate Stage 2 Stage 1		Nozzle pressure Stage 2 Stage 1		Gas flow rate Stage 2 Stage 1			
kW	kW	kW	mbar	mbar	m ³ /h	m ³ /h	mbar	mbar	m ³ /h	m ³ /h	ST1 P 1	ST2 P 9
678	420	610	6.7	1.9	77.9	47.8	5.2	1.5	73.1	45.3	10	30
927	465	834	11.8	2.8	106.6	53	9.1	2.3	100	50	14	50
1066	533	959	15	4.3	122.7	60.7	11.5	3.4	115	57.5	20	70
1141	570	1026	17.5	4.8	131.3	65	13.4	3.7	123	61.5	22	90
1168	584	1051	18.1	5	134.1	66.5	13.9	3.9	126	63	23	110
1193	597	1073	18.8	5.3	137.2	68	14.5	4	128.7	64.4	24	140

MG1550-LN T3D Burner output Stage 2 Stage 1		Boiler output where $\eta_k = 90\%$ Stage 2	Natural gas LL $H_{i,n} = 9,3$ [kWh/m ³]				Natural gas E $H_{i,n} = 10,4$ [kWh/m ³]				Air flap Cam setting	
			Nozzle pressure Stage 2 Stage 1		Gas flow rate Stage 2 Stage 1		Nozzle pressure Stage 2 Stage 1		Gas flow rate Stage 2 Stage 1			
kW	kW	kW	mbar	mbar	m ³ /h	m ³ /h	mbar	mbar	m ³ /h	m ³ /h	ST1 P 1	ST2 P 9
988	450	889	7.4	1.7	114.4	51.9	5.7	1.3	106.6	48.5	1	30
1247	623	1122	11.9	3.5	144.4	71	9.2	2.7	134.5	66.5	10	50
1389	694	1250	15	4.3	160.6	79	11.5	3.3	149.8	74	14	70
1463	731	1316	16.7	4.7	169	83.3	12.8	3.6	157.8	78	16	90
1511	755	1360	17.9	4.9	174.5	86	13.8	3.7	163	80.6	18	110
1550	775	1395	19	5.2	178.8	88.3	14.6	4	167.2	82.7	19	140

MG2000-LN T3D Burner output Stage 2 Stage 1		Boiler output where $\eta_k = 90\%$ Stage 2	Natural gas LL $H_{i,n} = 9,3$ [kWh/m ³]				Natural gas E $H_{i,n} = 10,4$ [kWh/m ³]				Air flap Cam setting	
			Nozzle pressure Stage 2 Stage 1		Gas flow rate Stage 2 Stage 1		Nozzle pressure Stage 2 Stage 1		Gas flow rate Stage 2 Stage 1			
kW	kW	kW	mbar	mbar	m ³ /h	m ³ /h	mbar	mbar	m ³ /h	m ³ /h	ST1 P 1	ST2 P 9
1272	717	1170	8.3	3.7	145.5	82.1	7	3.3	130.1	73.4	19	40
1435	717	1320	10.6	3.7	164.1	82.1	8.8	3.3	146.8	73.4	19	52
1685	870	1550	13.7	4.6	192.7	99.5	11.3	4.0	172.3	88.9	25	66
1815	1022	1670	16.2	6.0	207.6	116.9	13.3	5.2	185.7	104.5	30	72
2000	1022	1840	21.7	6.0	228.7	116.9	17.6	5.2	204.6	104.5	30	130

27. Troubleshooting

Defect determined:	Cause:	Remedy:	Fault code
Burner motor does not start up	Electric supply lead faulty	Rectify faults in electrical installation	
	Fuse faulty	Replace	
	Safety thermostat locked	Unlock	42 h
	Temperature of controller setting is exceeded	Renewed start attempt after temperature drop	
	MPA 22 faulty	Replace	04 h
	Leak	Rectify leak	44H / 43H
	No gas	Safeguard gas supply	
	Gas pressure monitor faulty	Replace gas train	22 h
	Filter in gas train dirty	Clean or replace	
	Air pressure switch not in idle position	Check air pressure switch (see page 7)	20 h
	Burner motor faulty	Replace	
	No load at terminal 5	Check plug connection and current path of solenoid valve	
	Mains voltage < 187 V	Rectify faults in electrical installation	
Burner starts up and switches to fault mode before or after expiry of safety period	Air pressure monitor does not switch through during pre-ventilation	See Page 7	21 h
	Ignition influencing of ionization monitor	See Page 8	26 h
	Gas solenoid valve does not open	Replace gas train	
	Starting gas quantity set too low	Increase starting gas quantity	
	No ignition	Check ignition electrode and setting, ignition transformer and cable	
	Phase and zero mixed up	Connect connector unit in correct phase sequence	
	Flame control faulty	Check according to Page 8	2BH
	Air pressure switch opens during operation	See Page 7	21 h
Gas nozzle dirty or faulty	Replace gas nozzle		
Flame extinguishes during operation	No gas	Safeguard gas supply	
	Filter in gas train dirty	Clean or replace	
	Flame blow-off	Incorrect burner setting	27 h
	Air pressure monitor contact opens	Check/replace air pressure switch	21 h
	Flame signal too weak	Measure flame signal, check ionisation electrode	27 h

Service mode - pneumatic gas-fired operation

The service mode serves to display the set parameters and to read out the fault memory. It can be invoked in any operating state of the burner.

Important:

setting values cannot be changed in service mode. If no key is pressed for longer than 20 sec., the display returns to standby mode.

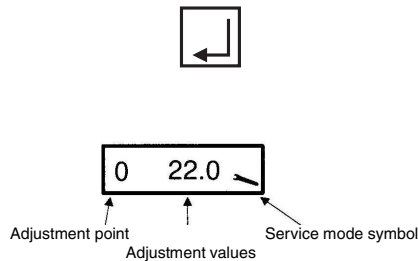

To access the service mode, press the **enter key** for approx. 2 sec. The following now appear on the display: point **P0** and the air flap positioning motor setting value at ignition in angular degrees, plus a wrench symbol denoting the service mode.

The following points can be retrieved by repeatedly pressing the enter key:

- The characteristic curves for points **P0**, **P1** and **P9**
- The last 6 fault messages **P10** to **P15** (see fault code MPA)
- The testing times of the valve proving system **P16** and **P17**
- The flame quality **P18**
- The eBus address of the MPA **P19**
- The switch setting of the valve proving system **P21**
- The eBus address of the external controller **P24**
- The modulation delay
- The set start points **P26**



To exit the service mode, please press the enter key or wait approx. 20 sec.

Information mode

The information mode is intended for display of consumption figures, operating hours and software data.

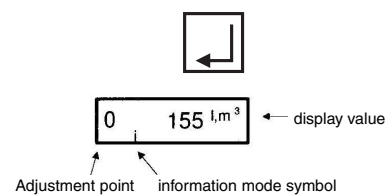

To access information mode, press the **enter key** for approx. 0.5 sec. A **zero** and a **value** appear on the display.

The following values can be queried in information mode under setting points 0 to 8. Retrieve by repeatedly pressing the enter key:

Important:

If no key is pressed for longer than 20 sec., the display returns to normal operating mode.

- 0 = fuel consumption
- 1 = total operating hours
- 2 = for oil only
- 3 = for oil only
- 4 = number of successful startups
- 5 = display of software version
- 6 = software creation date
- 7 = hardware number
- 8 = date of production

Troubleshooting the MPA

Code	Description
04 h	Internal hardware fault
05 h	Internal hardware fault
06 h	Internal hardware fault
07 h	Internal hardware fault
09 h	Internal hardware fault
10 h	Internal hardware fault
11 h	Internal hardware fault
12 h	Internal hardware fault
13 h	Internal hardware fault
14 h	Internal hardware fault
15 h	Internal hardware fault
20 h	Air pressure switch is not in idle position
21 h	Failure of air pressure switch
22 h	Failure of gas pressure monitor
25 h	No flame after safety period
26 h	Outside light
27 h	Flame failure during operation
29 h	Internal hardware fault
2AH	Internal hardware fault
2BH	Short-circuit in photo resistor or internal fault
2CH	Internal hardware fault
30 h	Internal hardware fault
31 h	Internal hardware fault
32 h	Internal hardware fault
33 h	Internal hardware fault
34 h	Internal hardware fault
42 h	Safety chain interrupted
43 h	Y3 found to be leaking during leak check
44 h	Y3 found to be leaking during leak check
45 h	Internal hardware fault
46 h	Internal hardware fault
47 h	Internal hardware fault
48 h	Internal hardware fault
4AH	Internal hardware fault
5BH	Internal hardware fault
4CH	Internal hardware fault
4DH	Internal hardware fault
4EH	Internal hardware fault
50 h	Internal hardware fault
51 h	Internal hardware fault
52 h	Internal hardware fault
53 h	Internal hardware fault
54 h	Internal hardware fault
55 h	Internal hardware fault
56 h	Internal hardware fault
57 h	Internal hardware fault
58 h	Internal hardware fault
59 h	Internal hardware fault

Code	Description
5AH	Internal hardware fault
5CH	Internal hardware fault
5DH	Internal hardware fault
5EH	Internal hardware fault
63 h	Internal hardware fault
64 h	Internal hardware fault
65 h	Internal hardware fault
67 h	Internal hardware fault
68 h	Incorrect feedback from air flap positioning drive (check connector and cable, actuator drive mounting and air flap mechanism)
6AH	Air-flap actuator position is out of tolerance (check connector and cable, actuator drive mounting and air flap mechanism)
6CH	Internal hardware fault
6DH	Internal hardware fault
6EH	Actuator drive interchanged or incorrectly connected
6FH	Burner detection error
70 h	Internal hardware fault
71 h	Internal hardware fault
73 h	Internal hardware fault
74 h	Internal hardware fault
75 h	Internal hardware fault
76 h	Internal hardware fault
77 h	Internal hardware fault
78 h	Internal hardware fault
79 h	Internal hardware fault

Process description

Startup tests	Processor and program memory test / move actuator drives to reference position
State 01	Startup decision (heating request present)
State 02	Blower idle state check
State 03	Blower startup
State 04	Preventilation / operation of gas flap actuator over speed range
State 05	Preventilation / activate and test watchdog
State 06	Preventilation / move gas flap actuator to ignition position
State 07	Move air flap actuator to ignition position
State 08	Pre-ignition depending on parameters
State 09	Startup safety period
State 10	Stabilisation period
State 11	Move positioning drive from ignition point to operating characteristic
State 12	Operation
State 13	VPS - evacuate valve cavity / (post-ventilate)
State 14	Test duration Y2 / (remaining post-ventilation time)
State 15	VPS - fill valve cavity / (remaining post-ventilation time)
State 16	Test duration Y3 / (remaining post-ventilation time)
State 17	Remaining post-ventilation time
State 18	Restart disable time / waiting loop for low gas program
State 20	Standby position

28. Adjustments log

Please enter the measured values into the Adjustments log.

Boiler type	Gas fitting

Measured values		min.	max.	Date
P0 (start point)				
P1 (min load)				
P9 (max load)				
Flue gas temperature	°C			
Carbon dioxide (CO ₂ level)	%			
O ₂ content	%			
CO level	%			
Flue	mbar			
Nozzle pressure	mbar			
Boiler pressure	mbar			
Room temperature	°C			
Gas type				
Setting value V at the fitting				
Setting value N at the fitting				

29. Overall dimensions

All dimensions in mm

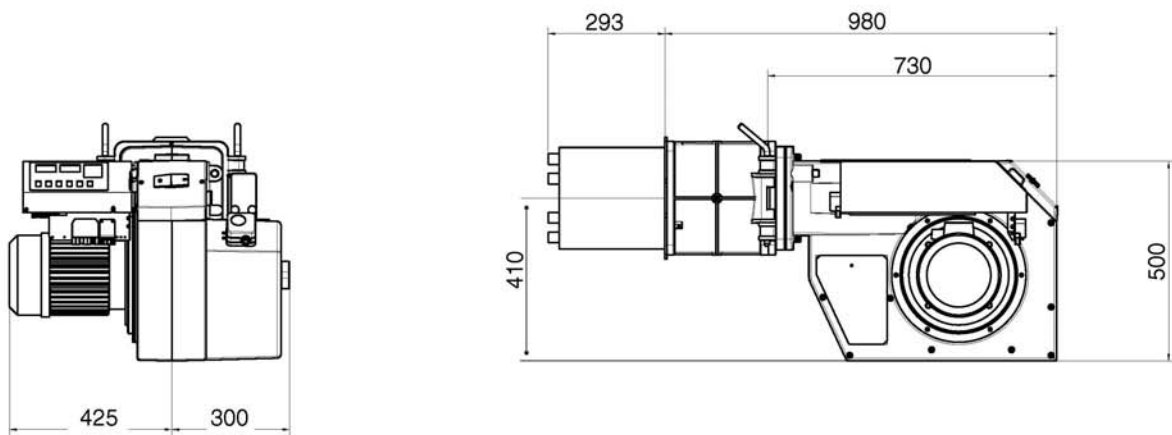

30. Working ranges

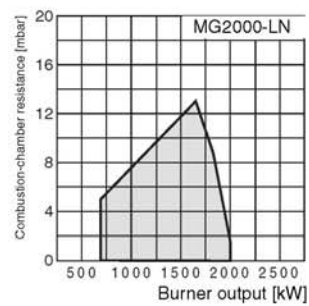
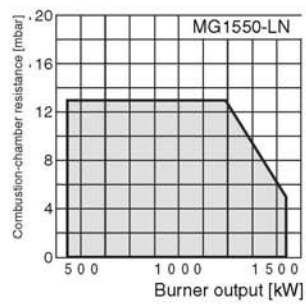
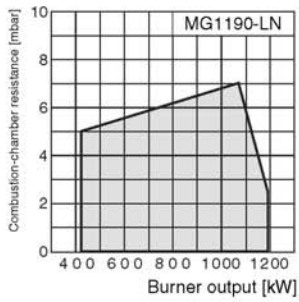

Working ranges according to EN 676.

Enertech Limited,
P O Box 1,
Vines Lane
Droitwich,
Worcestershire,
WR9 8NA

Tel: +44 (0) 1905 794331
Email: info@nu-way.co.uk

Fax: +44 (0) 1905 794017
Web: www.nu-way.co.uk

